

Transport dynamique dans les conducteurs mésoscopiques : aspects expérimentaux

Bernard Plaçais

Groupe de physique mésoscopique (MESO)

Laboratoire Pierre Aigrain, Ecole Normale Supérieure, Paris

Domaine vaste et très dynamique

- Dynamique de charge dans conducteurs quantiques (ce cours)
- Conducteurs diffusifs (cours G. Montambaux)
- Electronique quantique et photons RF (cours M. Devoret, Saclay)
- Moments d'ordre supérieurs du bruit, susceptibilité de bruit (Reulet et al., Orsay)
- Photo-détection électronique (MESO, Saclay, Orsay)
- Photo-détection GHz--THz (IEMN-Lille, LPS-Orsay, ce cours)
- Transport moléculaire dynamique ? (MPQ-Paris7, Néel-Grenoble)
- Dynamique du transport cohérent de spin (séminaire T. Kontos)
- Dynamique électro-mécanique (Grenoble, Barcelone)
-/.....

Nos conducteurs quantiques

Gaz d'électrons bidimensionnels (LPN)

Hétérojonction de semiconducteurs à modulation de dopage

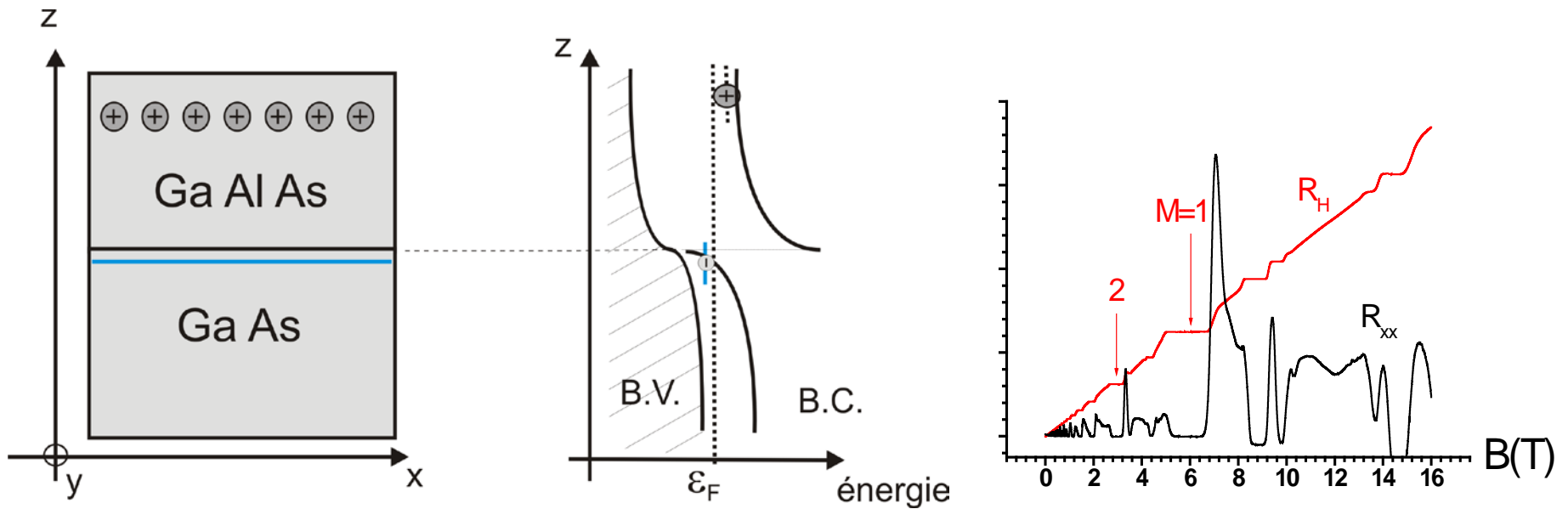

$$\mu = 240 \text{ m}^2 \text{ V}^{-1} \text{ s}^{-1} ; n_s = 10^{11} - 10^{13} \text{ cm}^{-2} ; \lambda_F \sim 30 \text{ nm} ; l_e > 10 \mu\text{m} ; l_\phi \approx 20 \mu\text{m}$$

Transport électronique balistique cohérent

Canaux de bord superballistiques

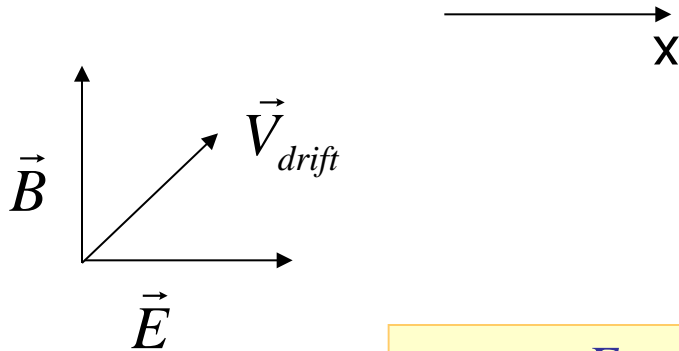
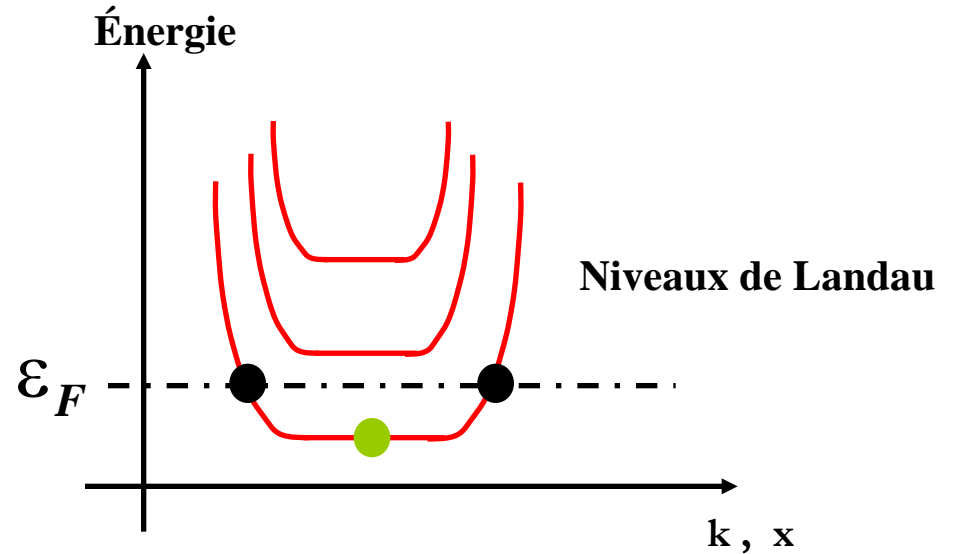
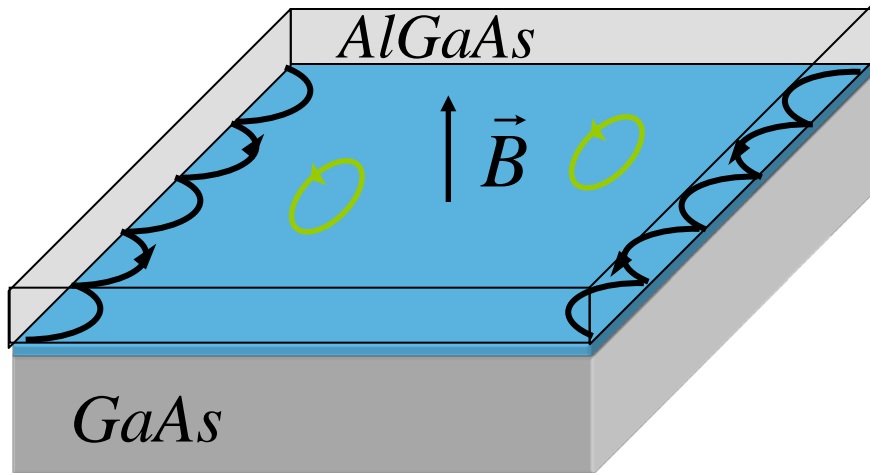

États de bord unidimensionnels
Dégénérescence de spin levée

$$V_{\text{drift}} = \frac{E}{B} \approx \frac{ne}{\epsilon B} \sim 10^5 \text{ m/s} \quad ; \quad l_e \leq l_{\text{edge}} \sim qqs100\mu\text{m}$$

nanotubes de carbone monoparois (MESO)

Conducteur balistique : 4 modes dégénérés spin et orbite

Nanotube (9,0) zigzag

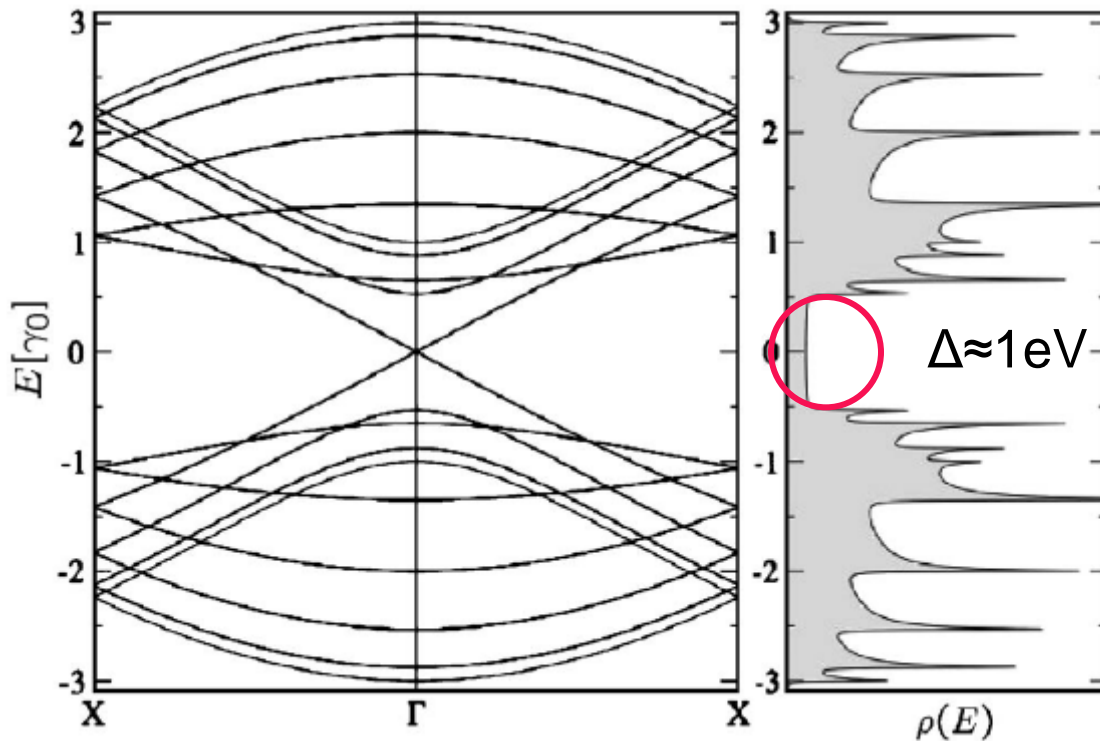

- $E = \pm \hbar k v_0$
- $v_0 = 8 \cdot 10^5 \text{ m/s}$
- $d_{(\text{nm})} = 0.076 \sqrt{m^2 + n^2}$
- $\gamma_0 = 2.9 \text{ eV}$

$$V_F \sim 10^6 \text{ m/s} \quad ; \quad l_e > 1 \mu\text{m}$$

Electronic and transport properties of nanotubes, J.C. Charlier, X. Blase, S. Roche, RMP 79, 677 (2007)

Nanotube semiconducteur

Nanotube (10,0) zigzag

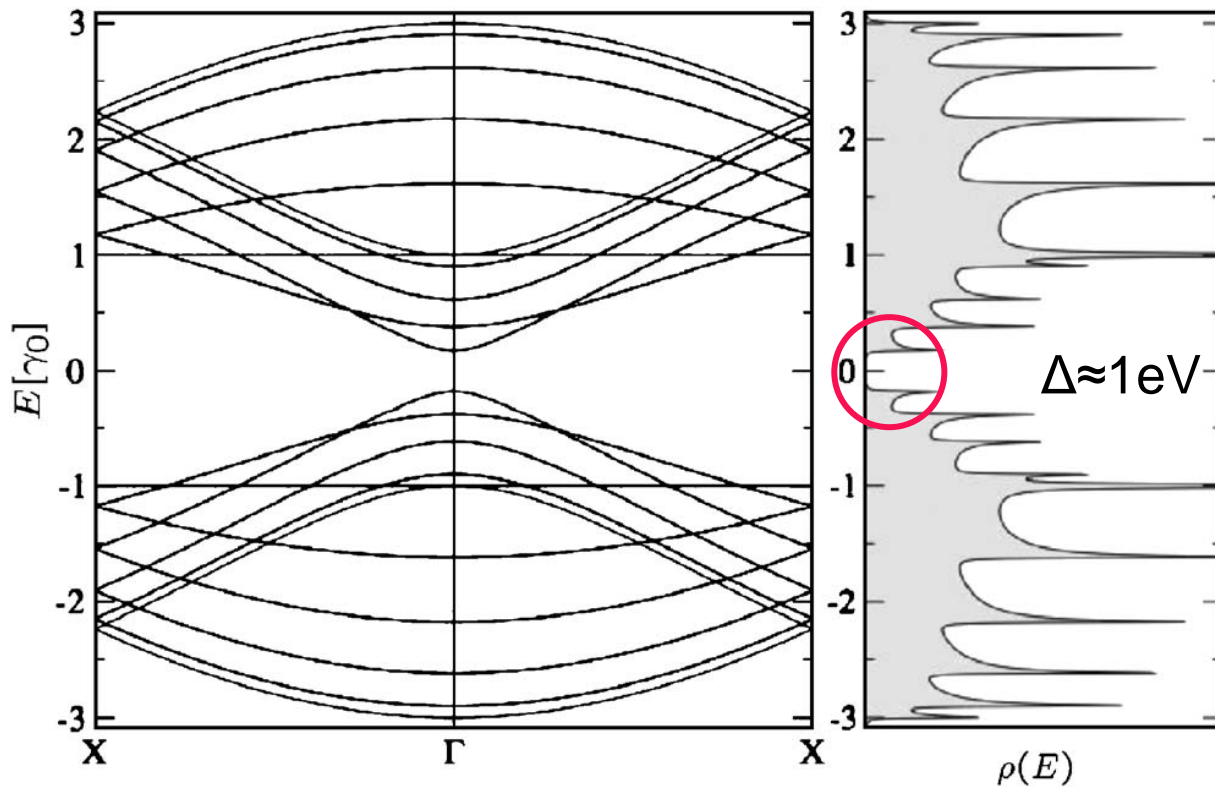

- $E = \pm \sqrt{(m^* v_0)^2 + (\hbar k v_0)^2}$
- $v_0 = 8 \cdot 10^5 \text{ m/s}$
- $v_F = v_0 \frac{\epsilon_F - \epsilon_g}{\Delta}$
- $m^* \leq \frac{m_0}{13} \frac{1}{d_{(\text{nm})}}$
- $d_{(\text{nm})} = 0.076 \sqrt{m^2 + n^2}$
- $\gamma_0 = 2.9 \text{ eV}$

(Charlier, Blase, Roche, RMP 2007)

Spectroscopie d'un nanotube semiconducteur (croissance CVD)

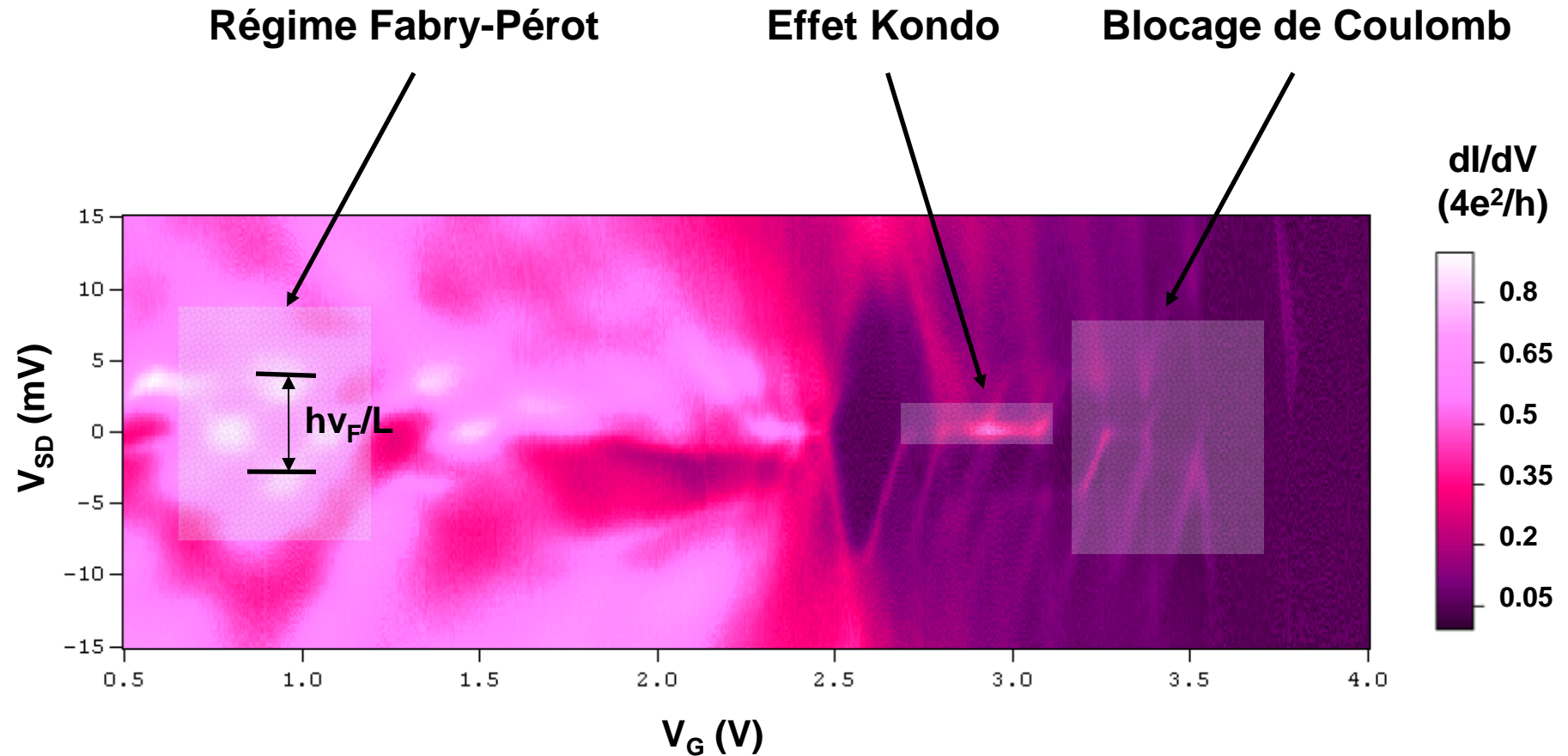

Plan du cours

A. Introduction à la dynamique mésoscopique

1. Introduction
2. Apport des hautes fréquences
3. Mesurables

B. Techniques expérimentales

1. Paramètres de diffusion
2. Montages de mesure de signaux rf faibles

C. Admittance de conducteurs quantiques

1. Relaxation de charge d'une capacité mésoscopiques
2. Inductance mésoscopique d'une barre de Hall
3. Dynamique de transistors à nanotube de carbone

D. Manipuler des électrons uniques

1. Injection d'électrons uniques
2. Vers la détection d'électrons volants

Introduction

optique électronique cohérente

Wave-packet approach to noise in multichannel mesoscopic systems, T. Martin, R. Landauer, PRB 45, 1742 (1992)

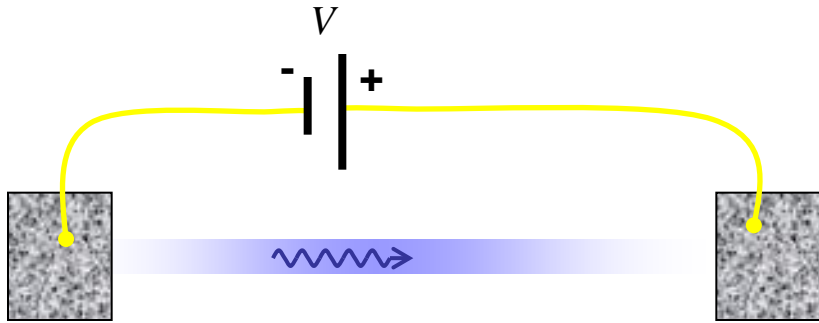

$$G = \frac{e^2}{h}$$

quantum inside

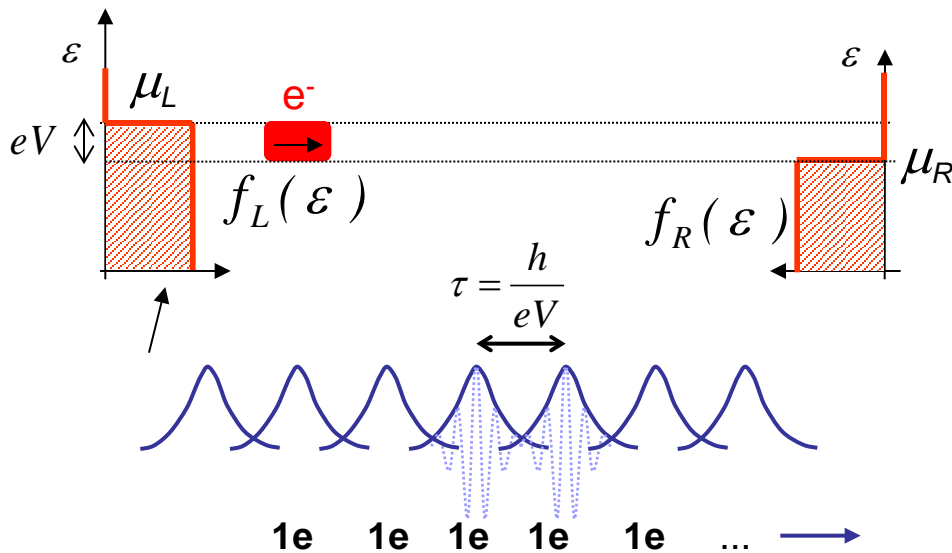

$$R = \frac{h}{e^2}$$

mais
25.8 kΩ ≫ 50Ω

$$\langle \Delta I^2 \rangle = 0 !!$$

$$I = e \cdot \frac{eV}{h}$$

Pauli

Heisenberg : $eV \cdot \tau \sim h$

Contrôle de la transmission d'un mode unique

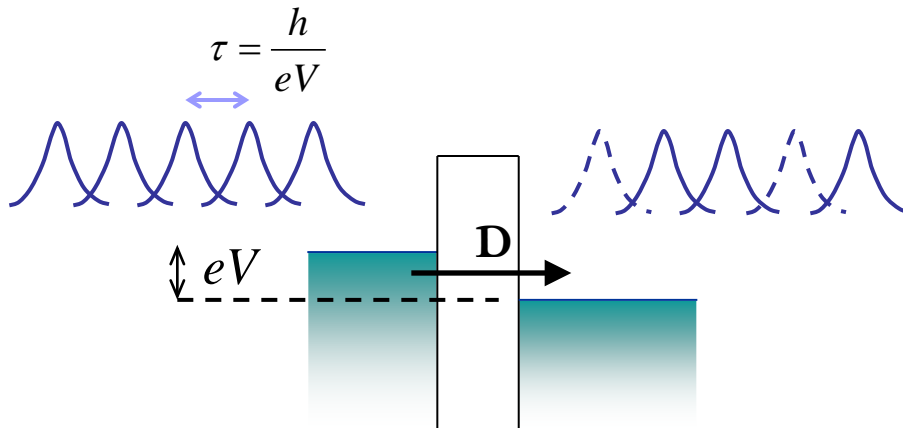

états de bord = équipotentiels

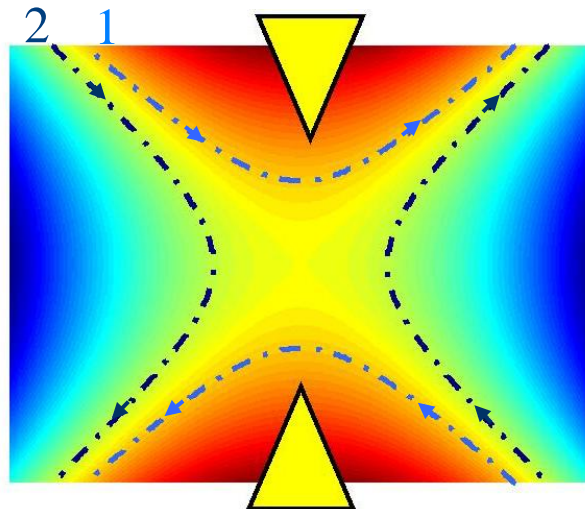

$$G = \frac{e^2}{h} \sum_n D_n$$

$$D_n \approx \left(1 + \exp - \frac{V_g - V_n}{\Delta V_0} \right)^{-1}$$

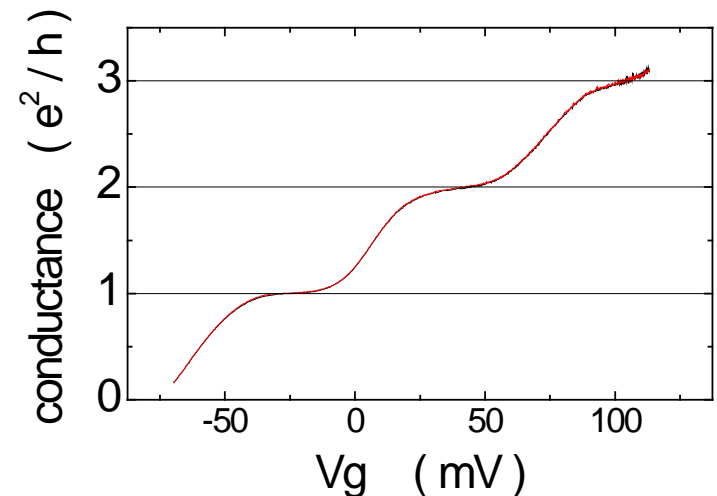

Quantized transmission of a saddle-point constriction, M. Büttiker, *Phys. Rev. B* 41, 7906 (1990).

Bruit de partition quantique

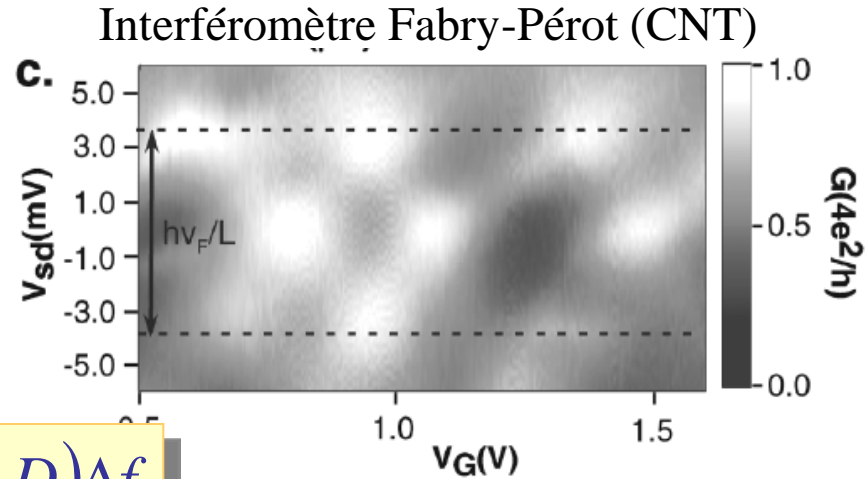
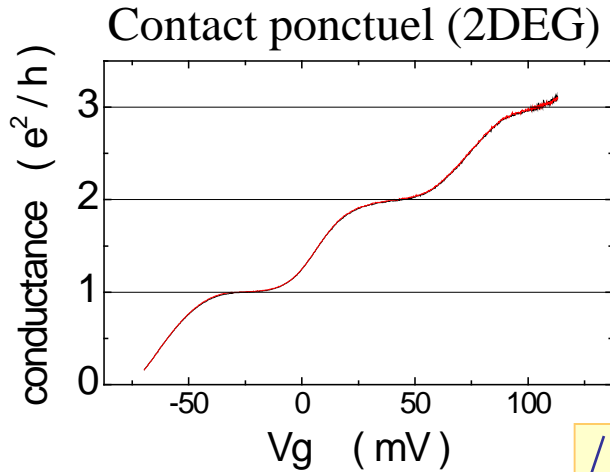

$$\langle \Delta I^2 \rangle = 2eI(1-D)\Delta f$$

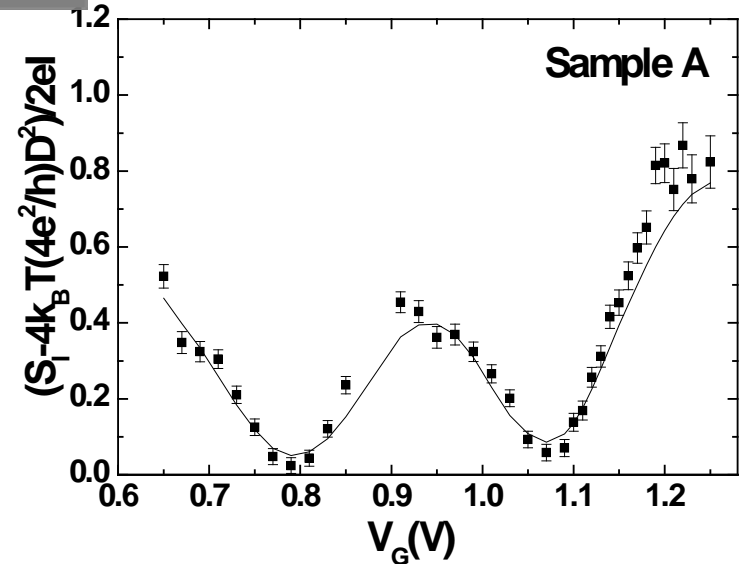
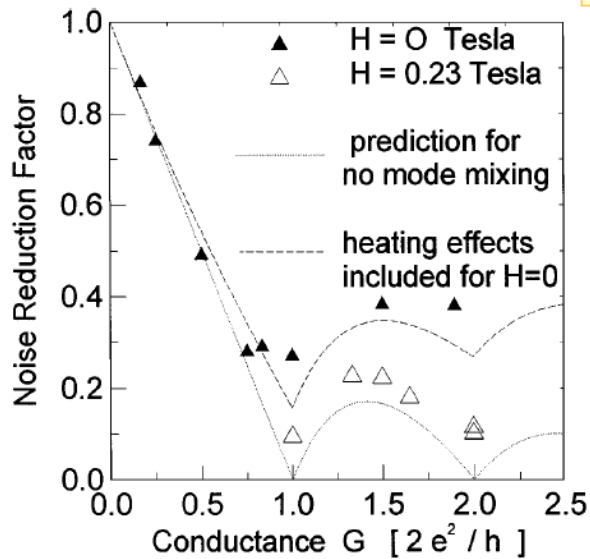

Shot noise suppression in QPC, Reznikov et al. PRL'95, Kumar et al. PRL '96, atomic contacts, van den Brom and Ruitenbeek PRL '99
Shot noise in Fabry-Pérot interférometers Based on carbon nanotubes, L. Hermann et MESO, PRL **99**, 156804 (2007),

interférences électroniques (P. Roche)

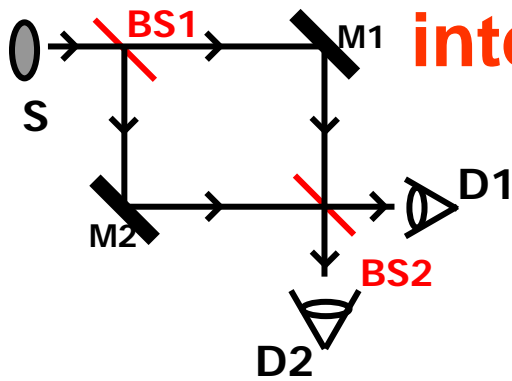

visibilité des franges des Mach-Zehnder

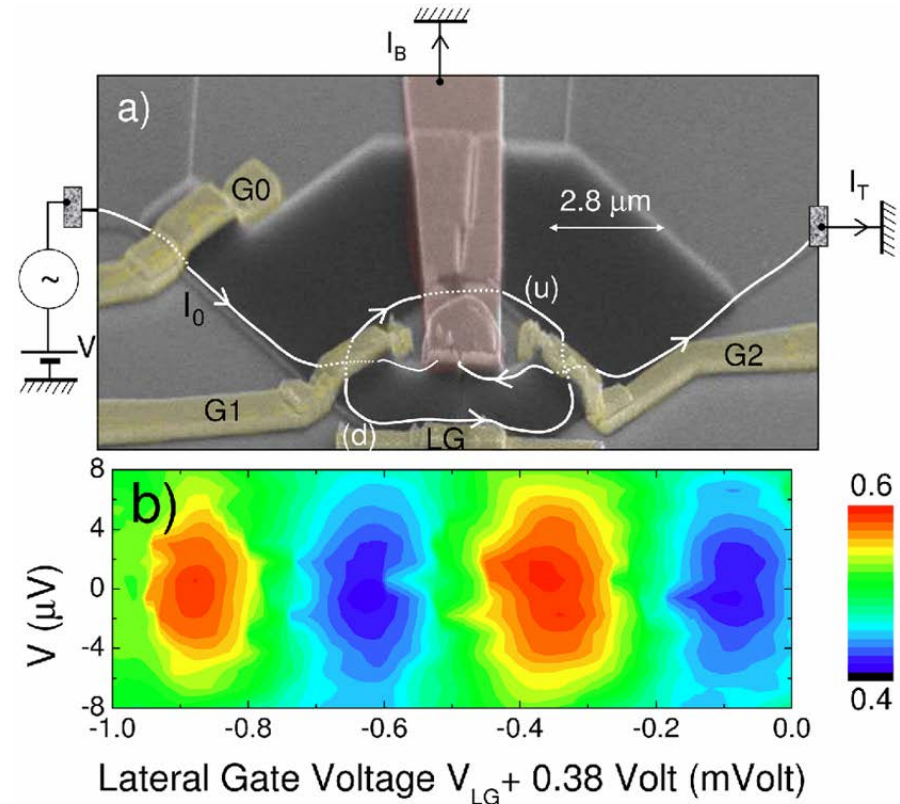
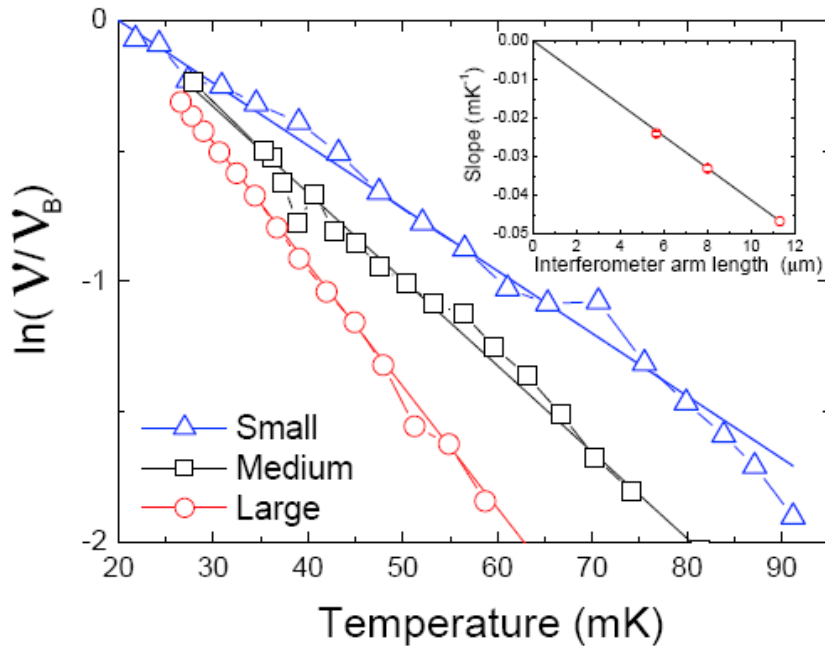

$$\nu = \nu_0 \exp\left(-\frac{L}{L_\phi(T)}\right); \quad L_\phi > 20 \mu\text{m} \text{ à } 20 \text{ mK}$$

Direct measurement of the coherence length, P. Rouilleau, et al. PRL 100, 126802 (2008).

Apport des hautes fréquences (ou des temps courts)

Mesure du temps de résidence électronique

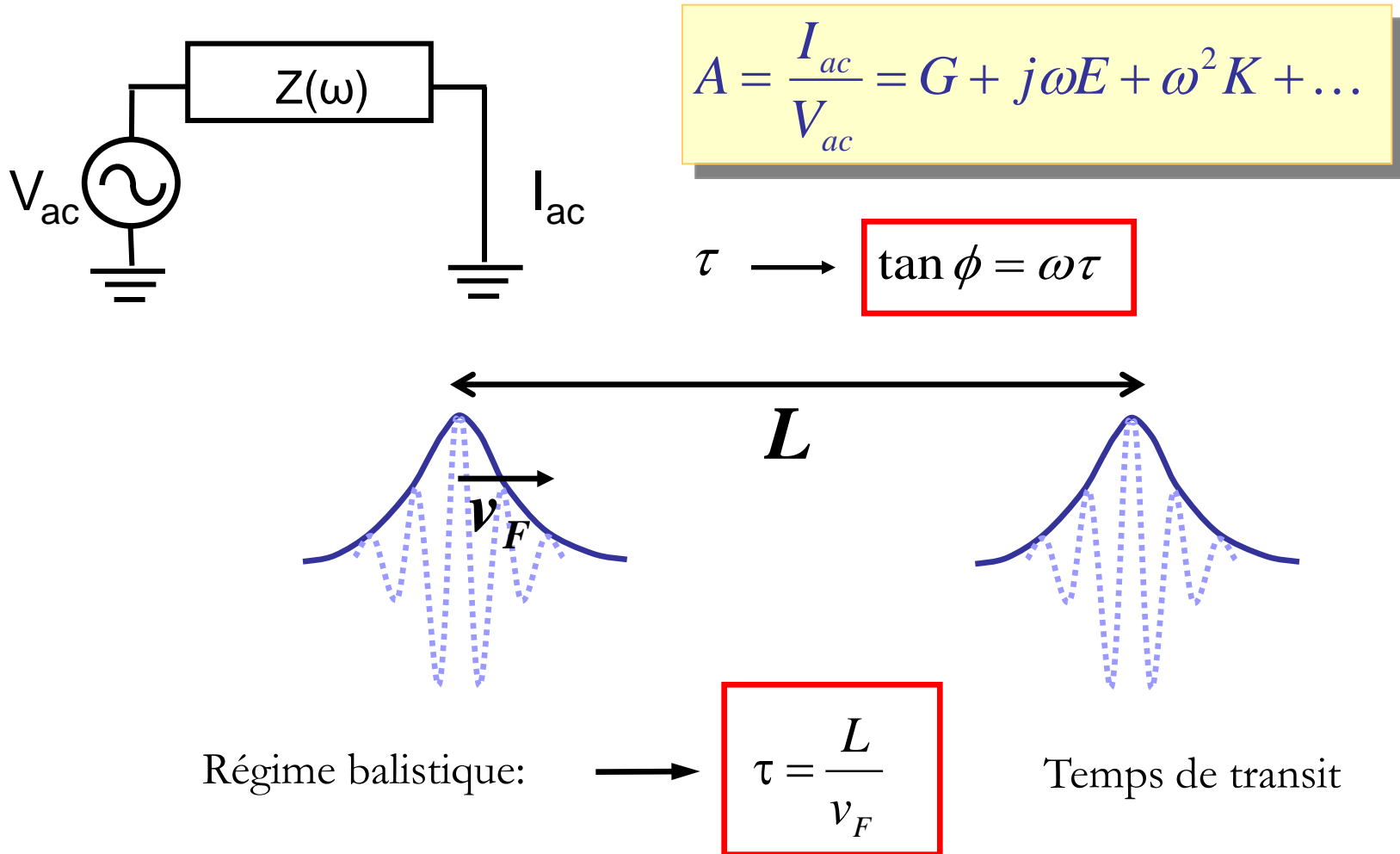

$$L \leq L_\phi \approx qqs \, 10 \mu\text{m}, \quad v_F \approx qqs \, 10^5 \text{ m.s}^{-1} \quad \Rightarrow \quad \tau \approx qqs \, 0.1 \text{ ns}, \quad f = (2\pi\tau)^{-1} \approx qqs \text{ GHz}$$

Inductance d'un fil diffusif cohérent

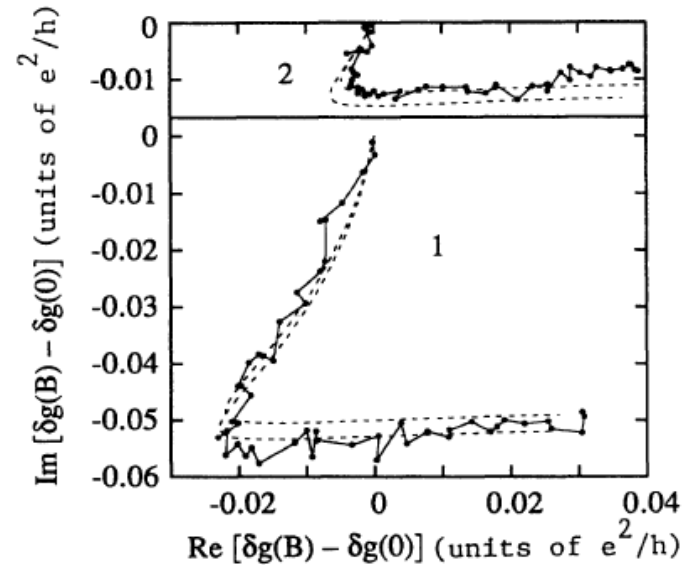
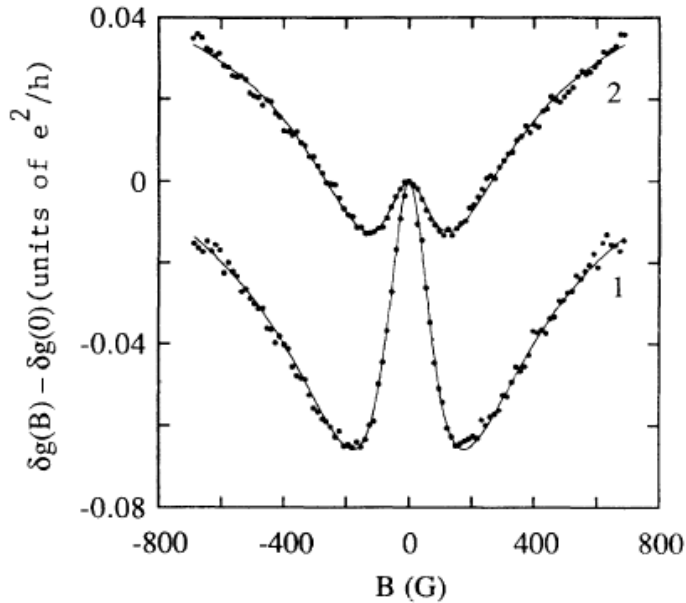

$$A(B) \approx G(B) - j\omega L(B)G^2 \quad ; \quad \delta A(B) = \frac{e^2}{h} \frac{1}{L} \left(L_0^{-2} + L_B^{-2} - \frac{i\omega}{D} \right)^{-1/2}$$

Temps de traversée d'un fil diffusif

*Weak-localization complex conductivity at 1GHz in disordered in Ag wires, J.B. Pieper, J.C. Price, J.M. Martinis, PRB 45, 3857 (1992).
High frequency conductivity of the high-mobility 2DEG, P. J. Burke et al. , APL 76, 745 (2000).*

2 terminaux - 2 contacts : inductance mésoscopique

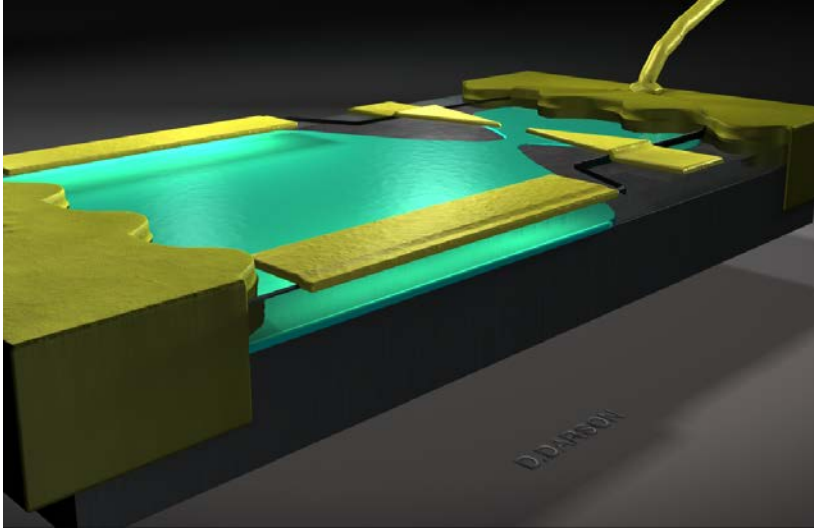

(c.f. : section C.2)

$$A = G + j\omega E = G(1 + j\omega\tau)$$

Temps de traversée d'une barre de Hall

Low frequency admittance of a quantized Hall conductor, T. Christen and M. Büttiker, PRB 53, 2064 (1996).

Low frequency admittance of a quantum point contact, T. Christen, M. Büttiker, PRL 77, 143 (1996)

Relaxation Time of a Chiral Quantum R-L Circuit, J. Gabelli, et al., PRL98, 166806 (2007)

1 contact - 1 grille : capacité mesoscopique

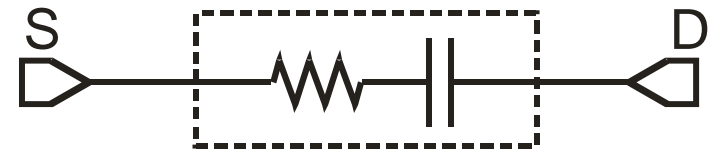
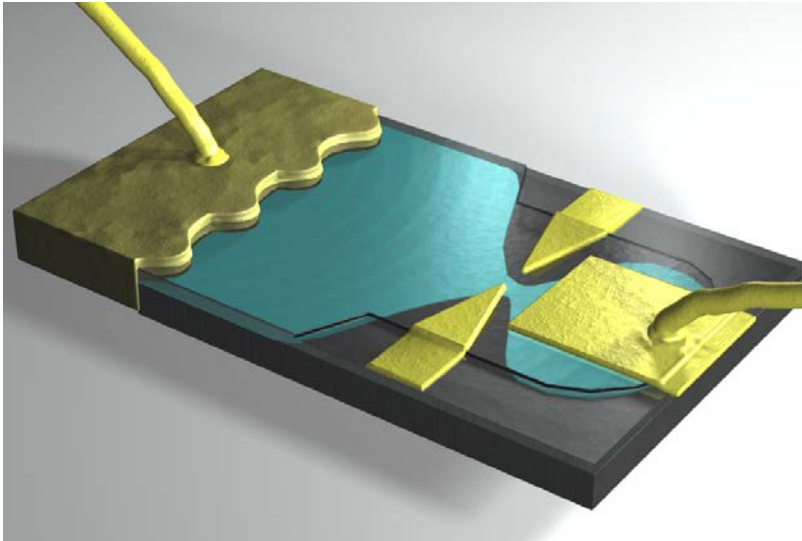

(c.f. : section C.1)

$$A = jC\omega - (C\omega)^2 R_q = jC\omega (1 + j\omega\tau)$$

Temps de charge et
résistance de relaxation de charge
(cohérent et incohérent)

Dynamic conductance and the scattering matrix of small conductors, M. Büttiker, A. Prêtre, H. Thomas, PRL70, 4114 (1993).
Dynamic admittance of mesoscopic conductors: Discrete-potential model, A. Prêtre, H. Thomas, M. Büttiker, PRB54, 8130 (1996).
Violation of Kirchhoff's Laws for a Coherent RC Circuit, J. Gabelli, et al., Science 313, 499 (2006).

2 contacts - 1 grille : le transistor mesoscopique

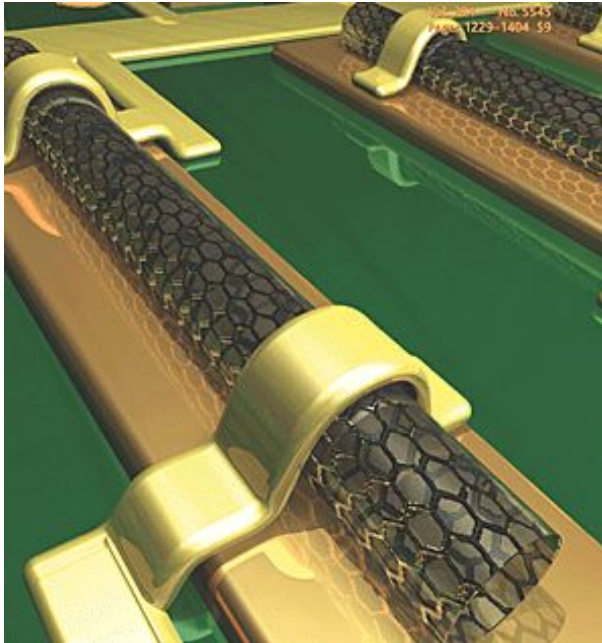

Matrices S , Z, Y ou ABCD

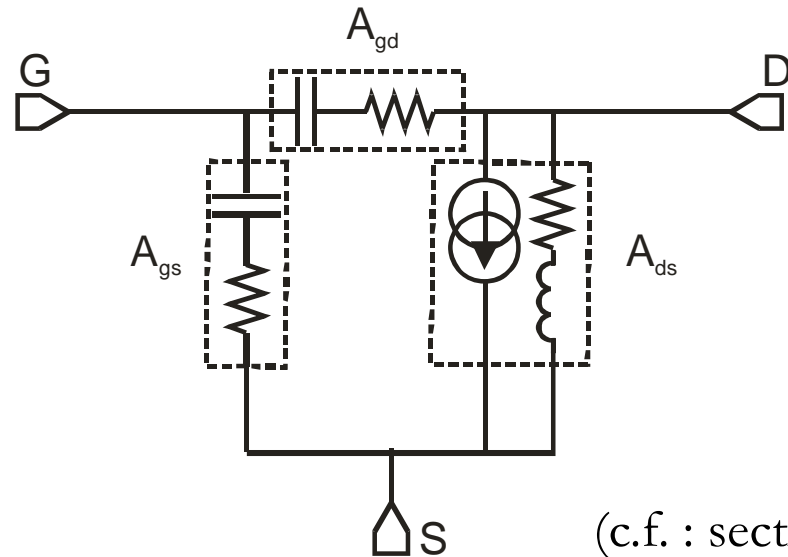

(c.f. : section C.3)

$$\begin{pmatrix} V_2 \\ I_2 \end{pmatrix} = \begin{bmatrix} A & B \\ C & D \end{bmatrix} \begin{pmatrix} V_1 \\ I_1 \end{pmatrix} ; \quad \left. \frac{I_2}{I_1} \right|_{V_2=0} = \frac{AD - BC}{A} = 1 + j \frac{\omega}{\omega_T}$$

Fréquence de transit

Single Carbon Nanotube Transistor at GHz, J. Chaste et al. MESO, Nanoletters 8, 525 (2008)

Polarisabilité d'anneaux mésoscopiques

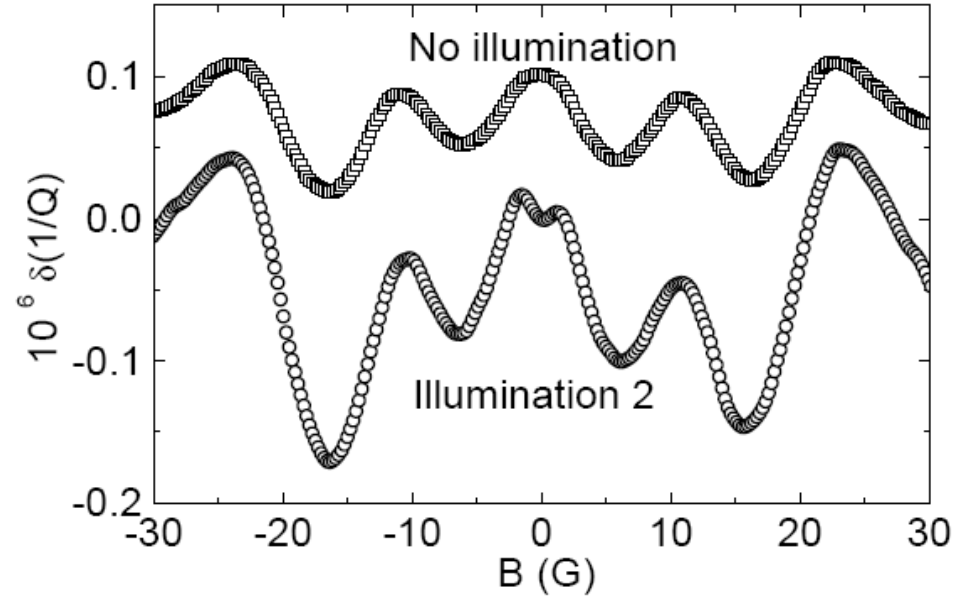
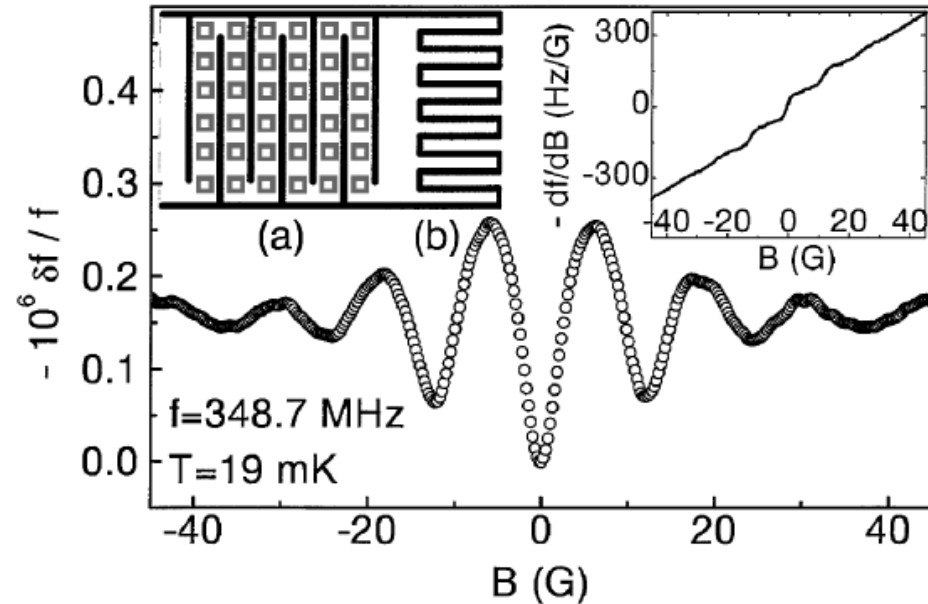
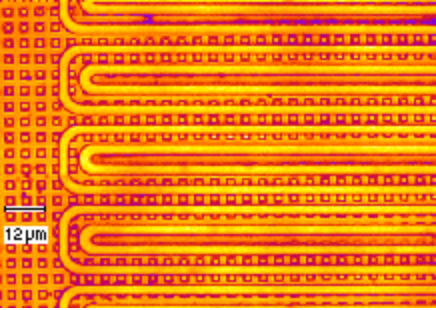

$$\delta\alpha(\varphi) = -\frac{\lambda_s}{L} + \frac{\varepsilon}{16\pi^2 \ln(R/W)} \frac{\Delta}{E_c} \frac{\lambda_s^2}{LW} (1 + j\omega\tau) \cos(\varphi/\varphi_0) \quad ; \quad \tau = \frac{2\pi}{\Delta}$$

Thèse B. Reulet, Flux-dependent screening in Aharonov-Bohm rings, R. Deblock et al., PRL 84, 5379 (2000)

Theorie, K.B. Efetov, PRL 76, 1908 (1996)

Modèle diffusif, Y. Noat, B. Reulet and H. Bouchiat, EPL 36, 701 (1996)

Du bruit rf
à
la manipulation d'électrons uniques

Singularité bruit à eV/h

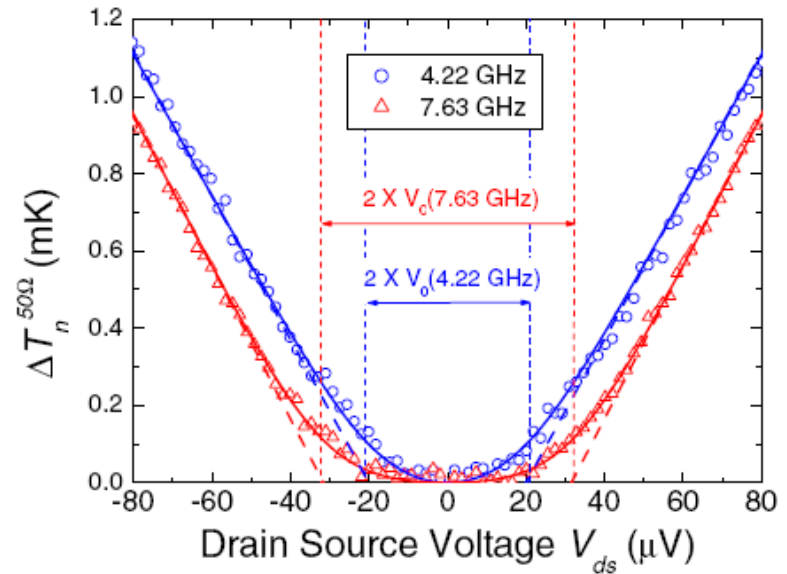
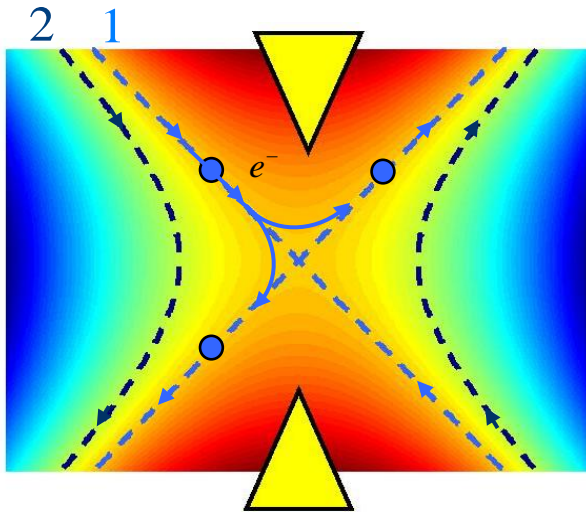

$$S_I(f, T, V) = 2G_0 \sum_i D_i (1 - D_i) \left(\frac{hf - eV}{e^{(hf - eV)/kT} - 1} + \frac{hf + eV}{e^{(hf + eV)/kT} - 1} - \frac{2hf}{e^{hf/kT} - 1} \right)$$

$$\xrightarrow{V \gg hf, kT} 2G_0 \sum_i D_i (1 - D_i) \left(eV - hf \coth \left(\frac{hf}{2kT} \right) \right)$$

Experimental Test of the High-Frequency Quantum Shot Noise Theory in a Quantum Point Contact
 E. Zakka-Bajjani, J. Segala, F. Portier, P. Roche, and D. C. Glatli, A. Cavanna, Y. Jin, PRL 99, 236803 (2007).

Comptage d'électrons (QPC-FET)

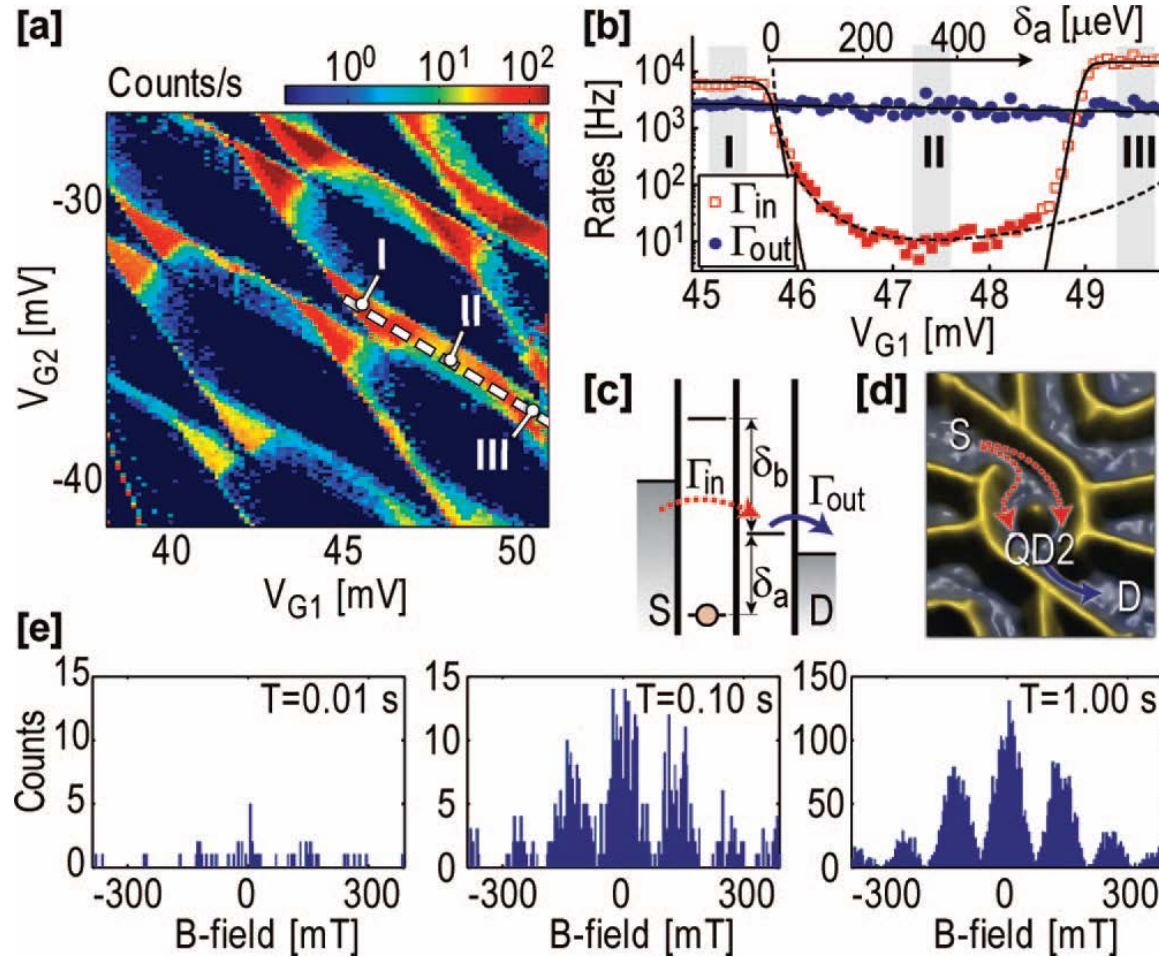

classique : $\tau \gg \tau_\phi$

Time-Resolved Detection of Single-Electron Interference, S. Gustavsson, R. Leturcq, M. Studer, T. Ihn, and K. Ensslin, D. C. Driscoll and A. C. Gossard, *Nanoletters* 8, 2547 (2008)

injecter des électrons uniques cohérents

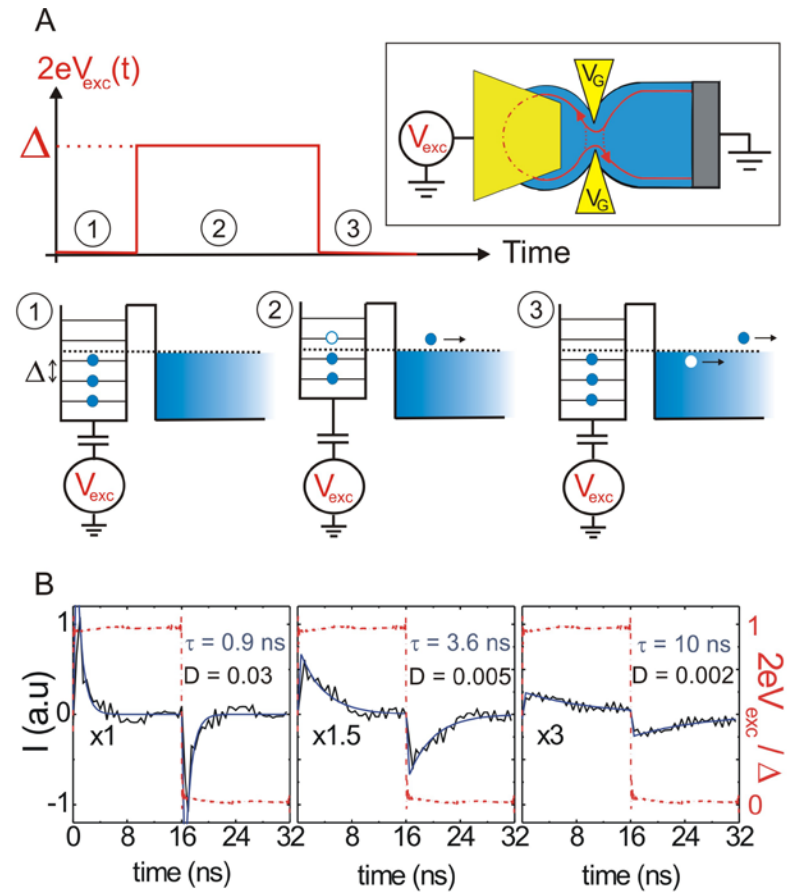
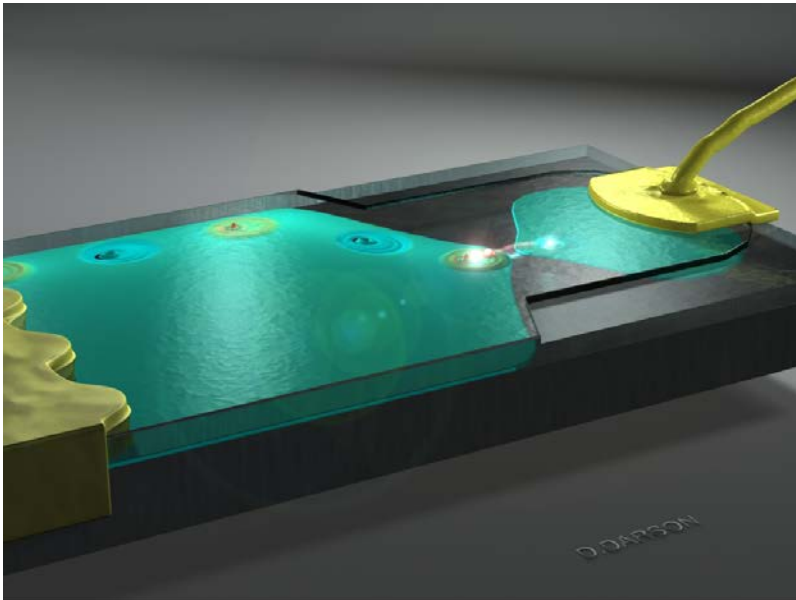

An on-demand single electron source, G. Fève et al. MESO, et al., Science 316, 1169 (2007).

Pour réaliser des collisions à deux électrons

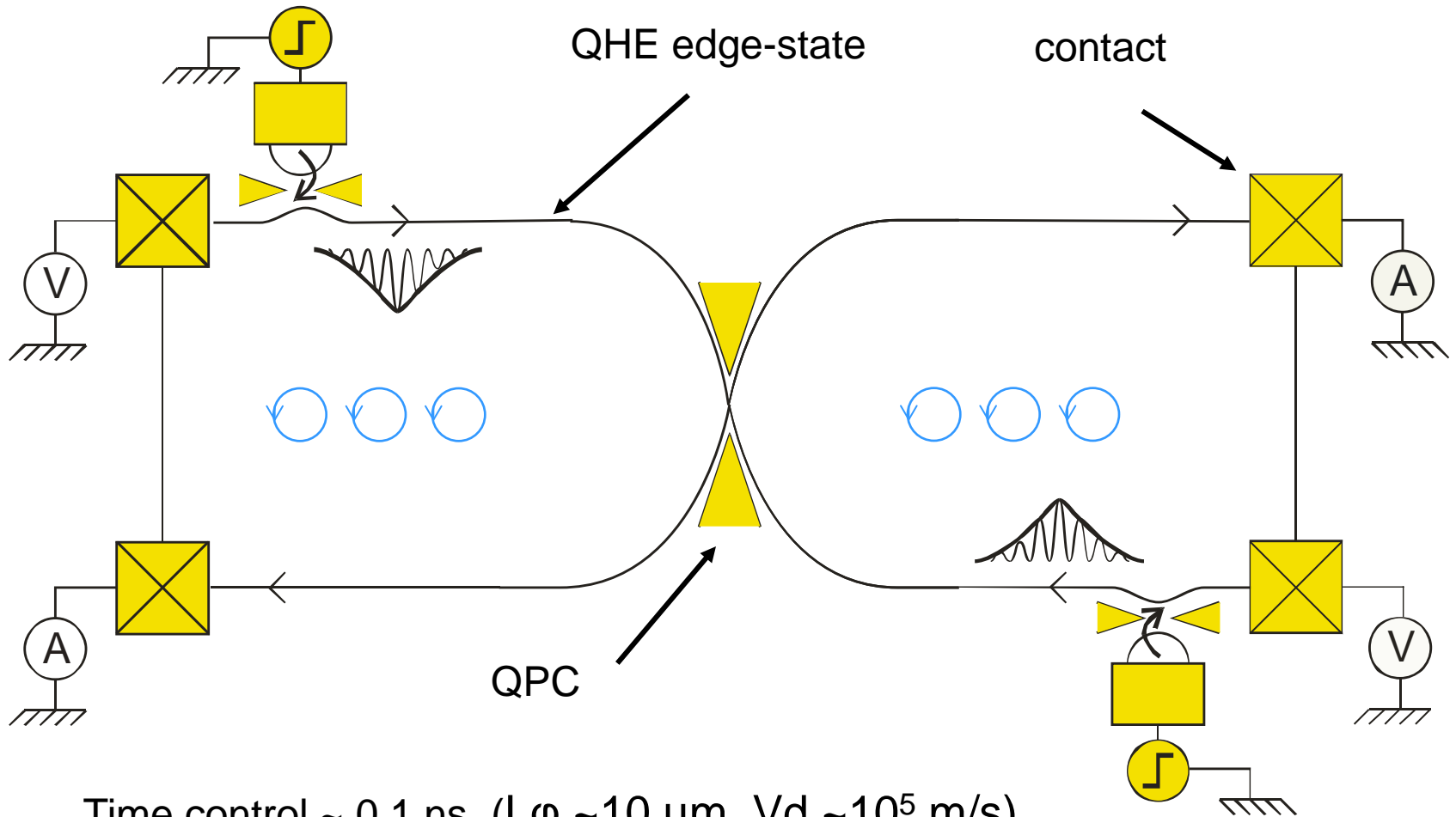

Time control ~ 0.1 ns ($L\phi \sim 10$ μm , $V_d \sim 10^5$ m/s)
Energy control

Posters Jeanine et François Parmentier

Mesurables rf

Capacité quantique

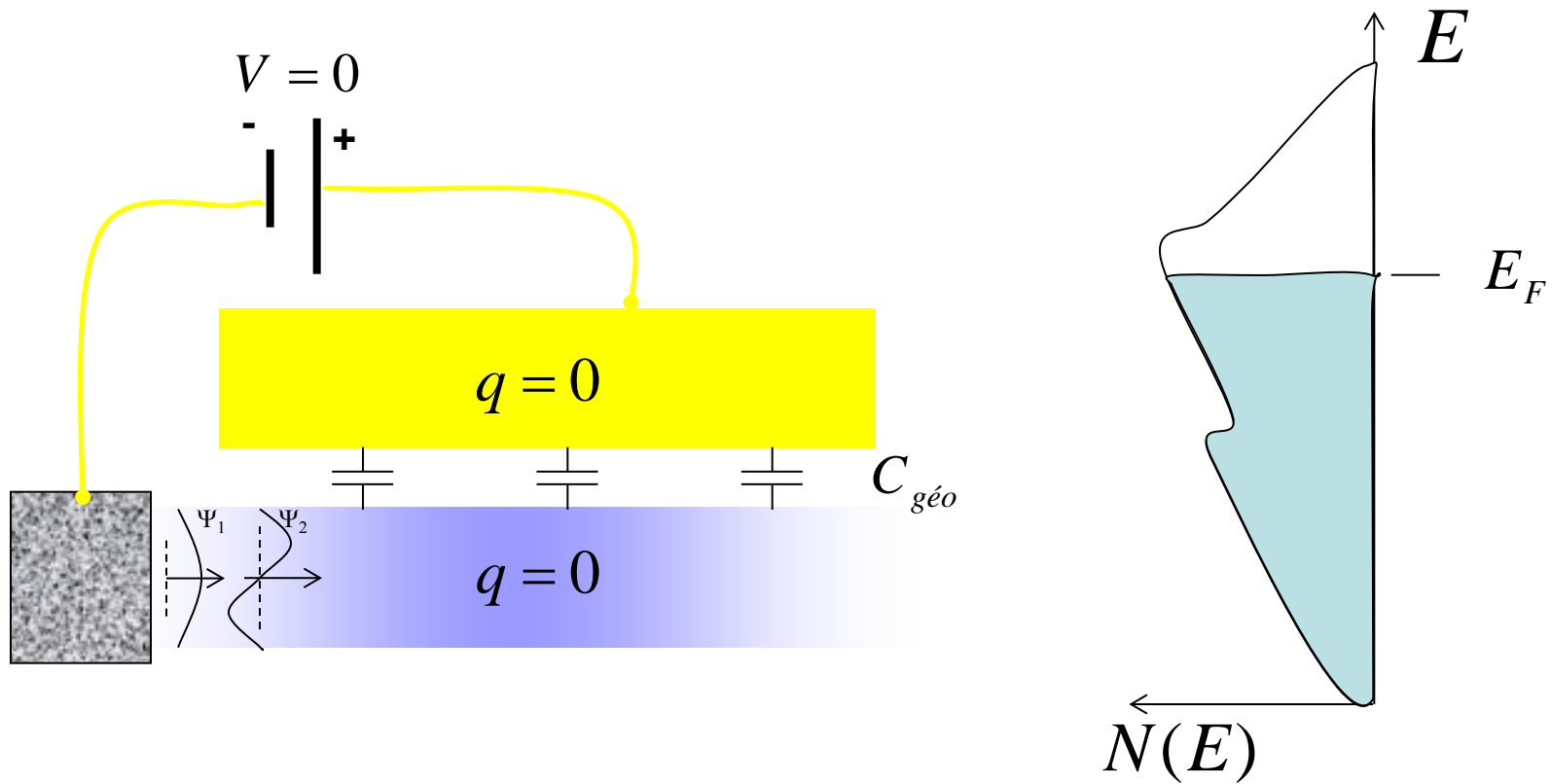

Capacité quantique

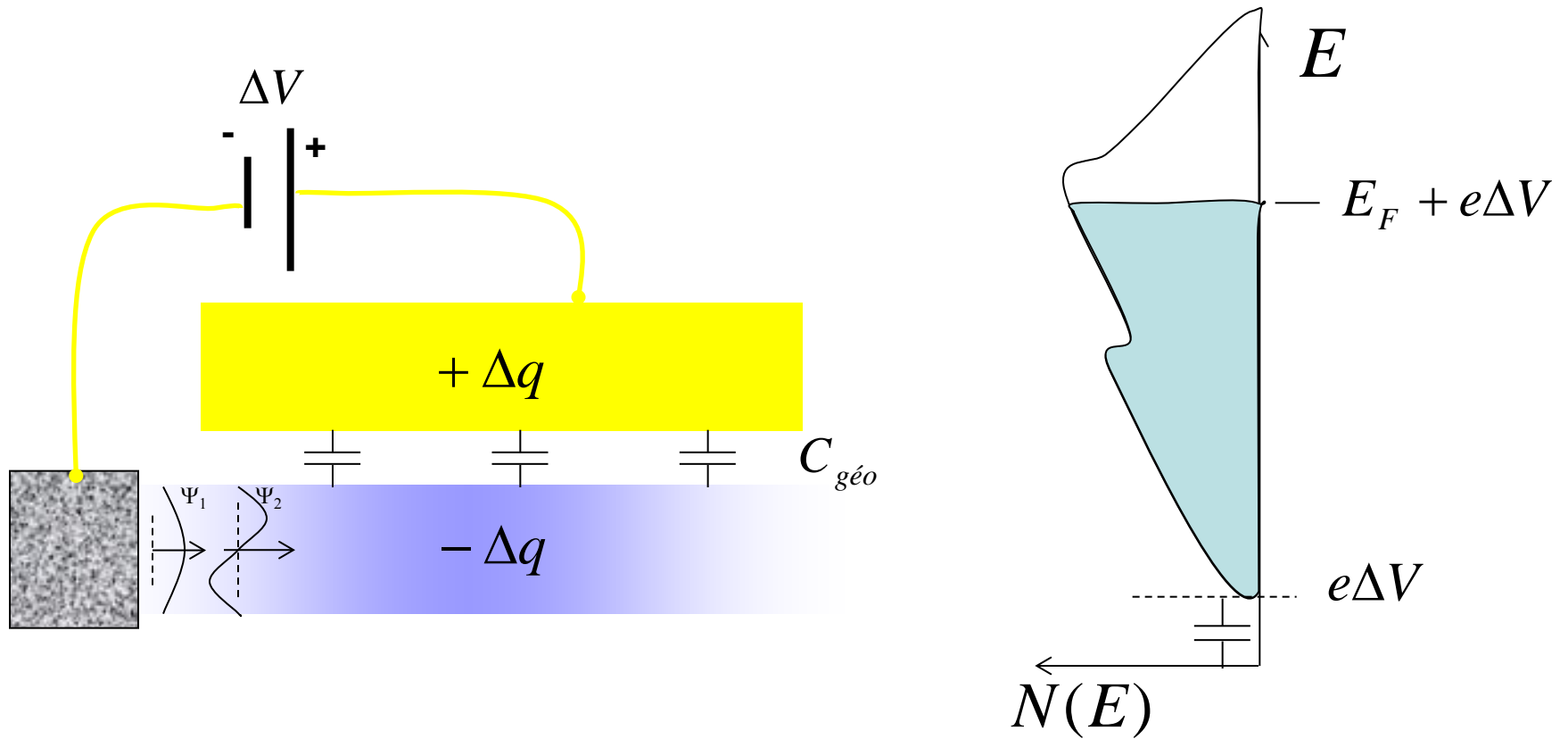

Capacité quantique

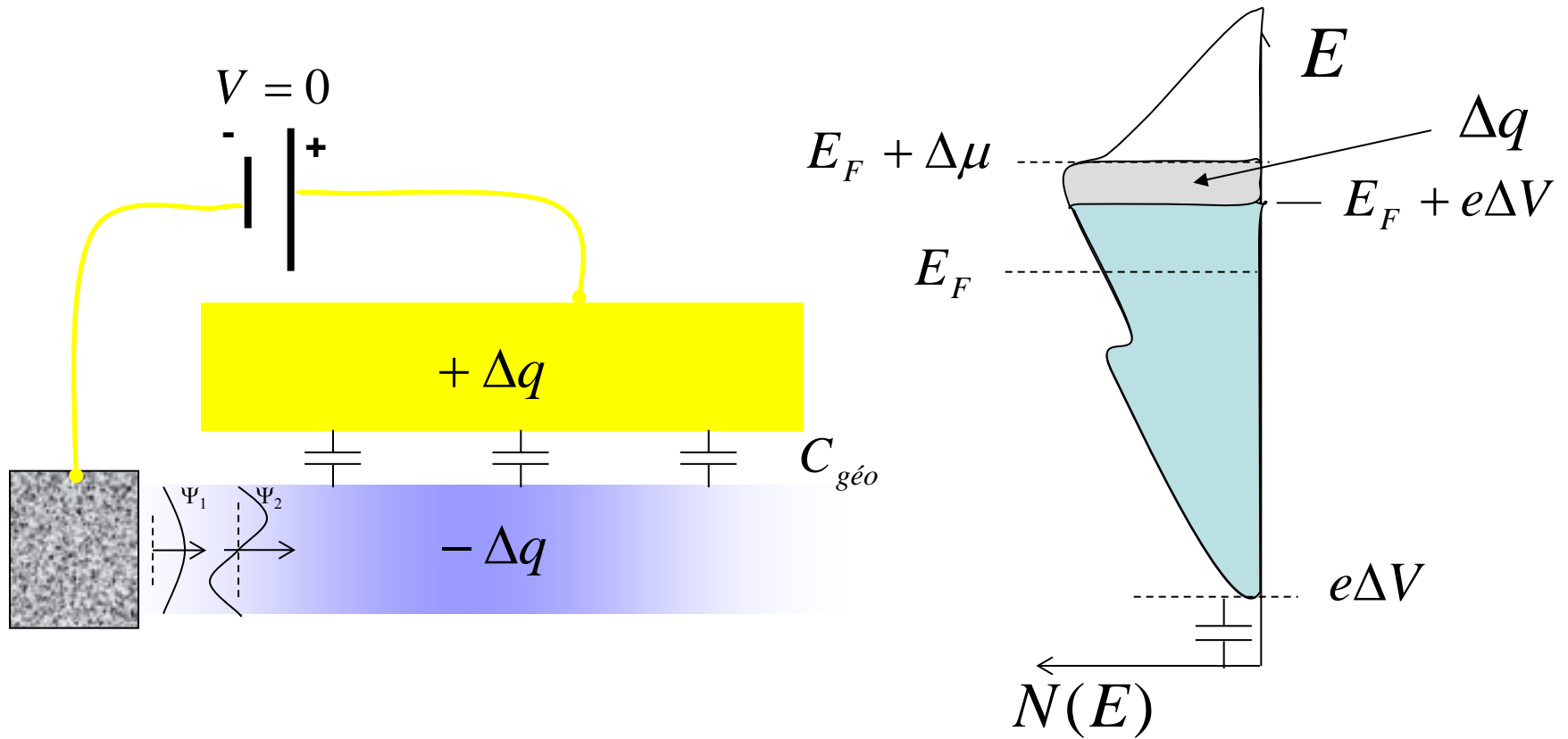

Capacité quantique

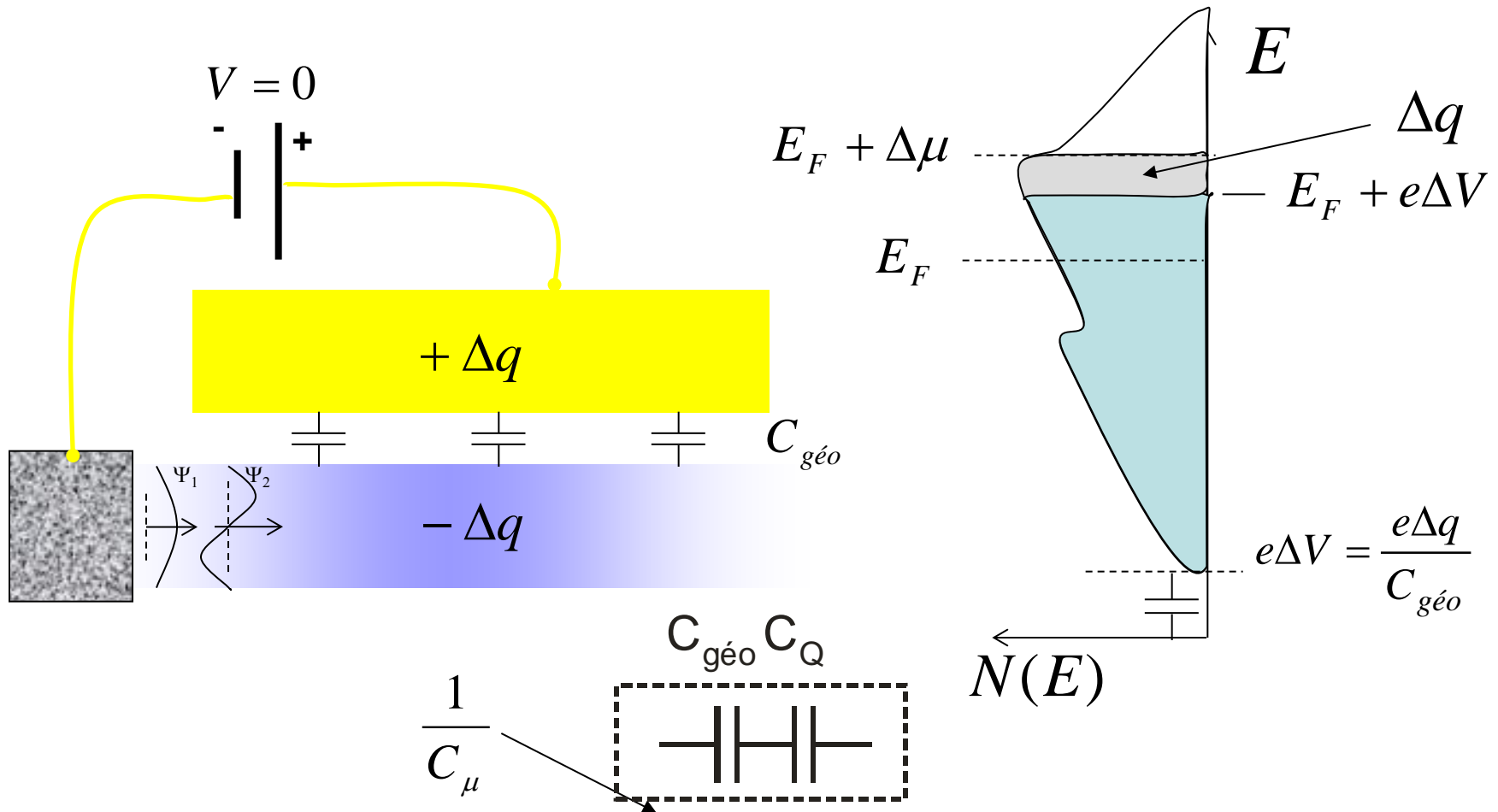

$$\Delta\mu_L = e\Delta V + \frac{\Delta q}{e} \frac{1}{N(E)} = e\Delta q \left(\frac{1}{C_{\text{géo}}} + \frac{1}{C_Q} \right), \quad C_Q = e^2 N(E_F) \propto N_{\text{modes}}$$

inductance cinétique

Inductance cinétique

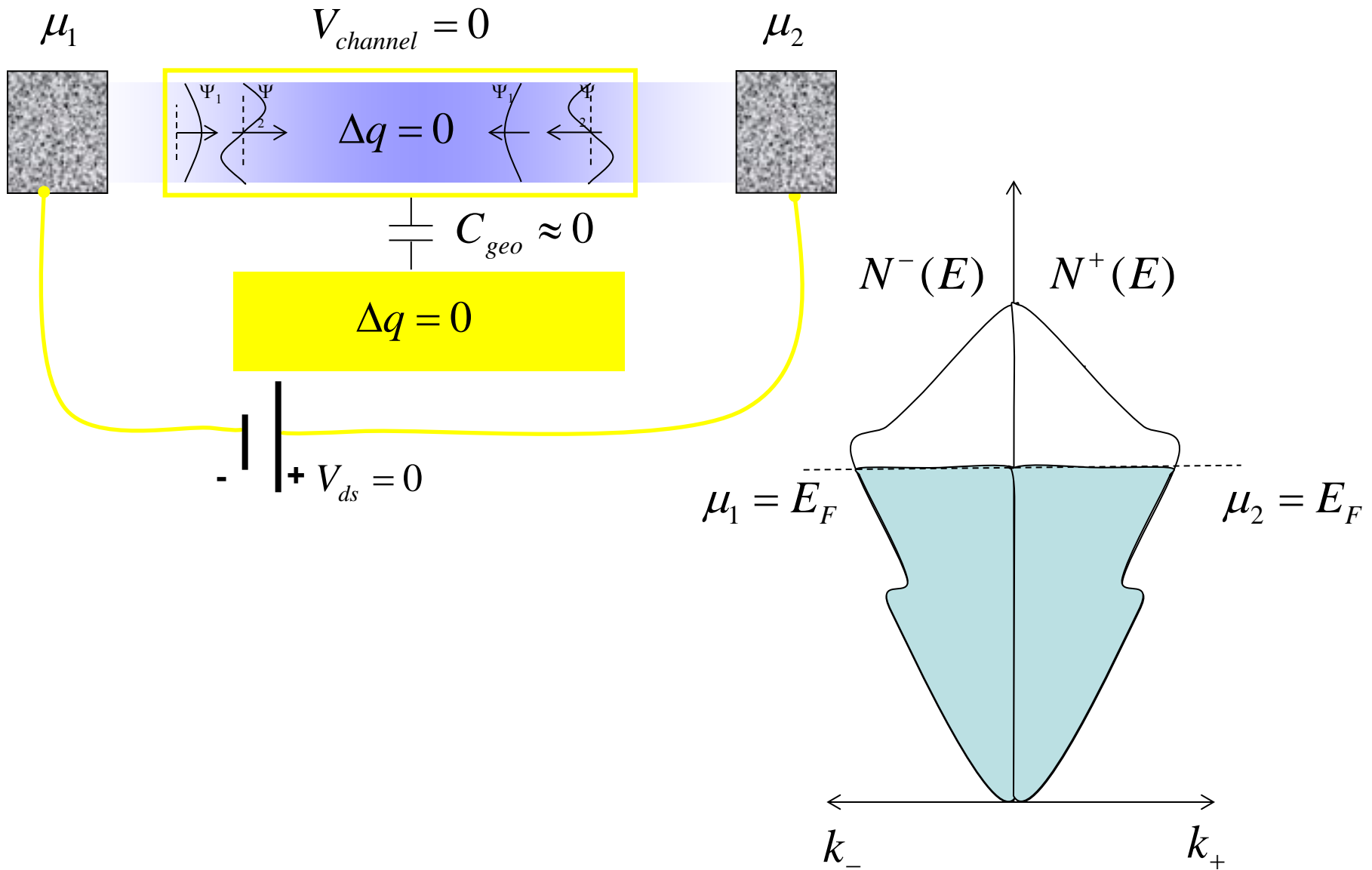

Inductance cinétique

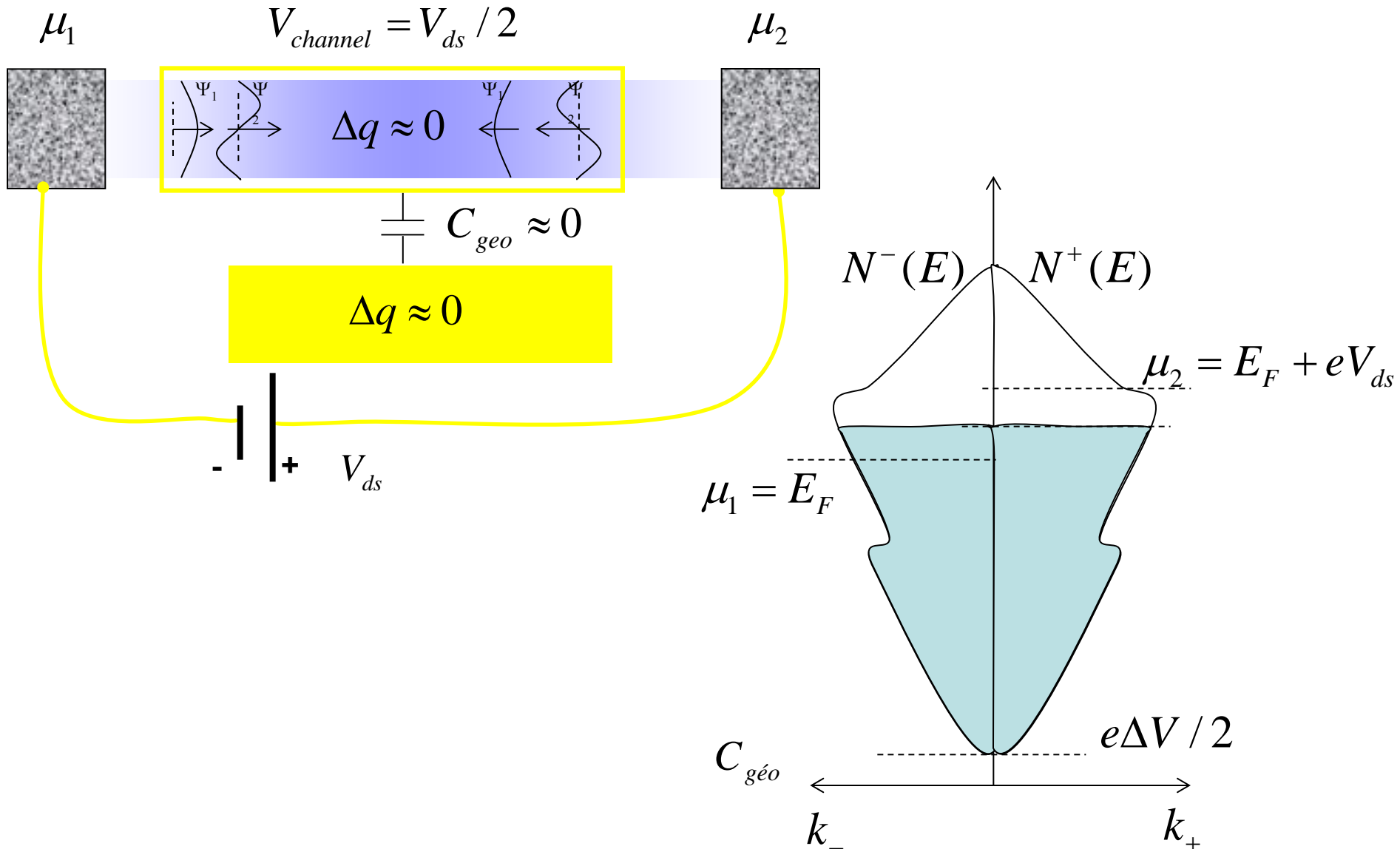

Inductance cinétique

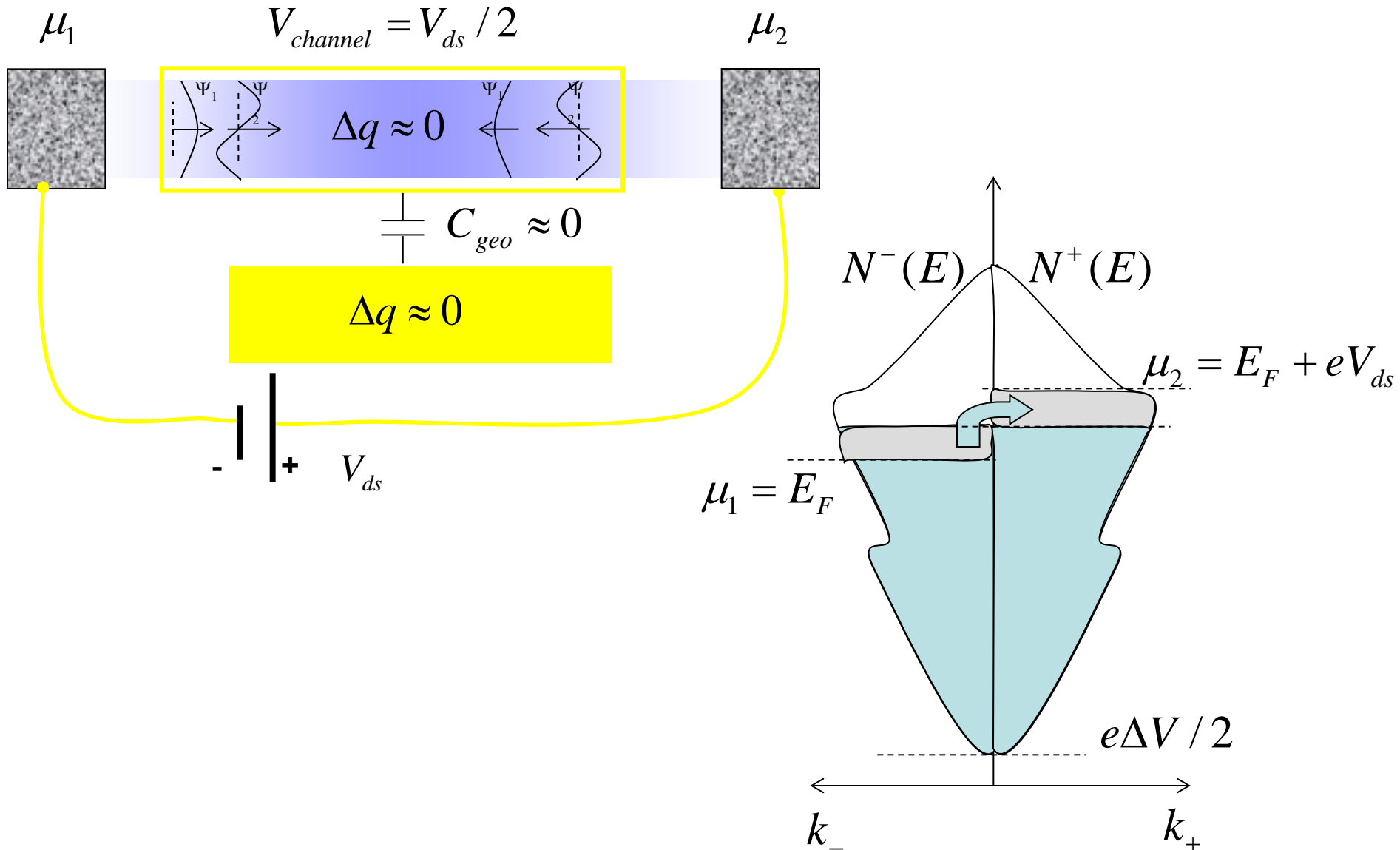

Inductance cinétique

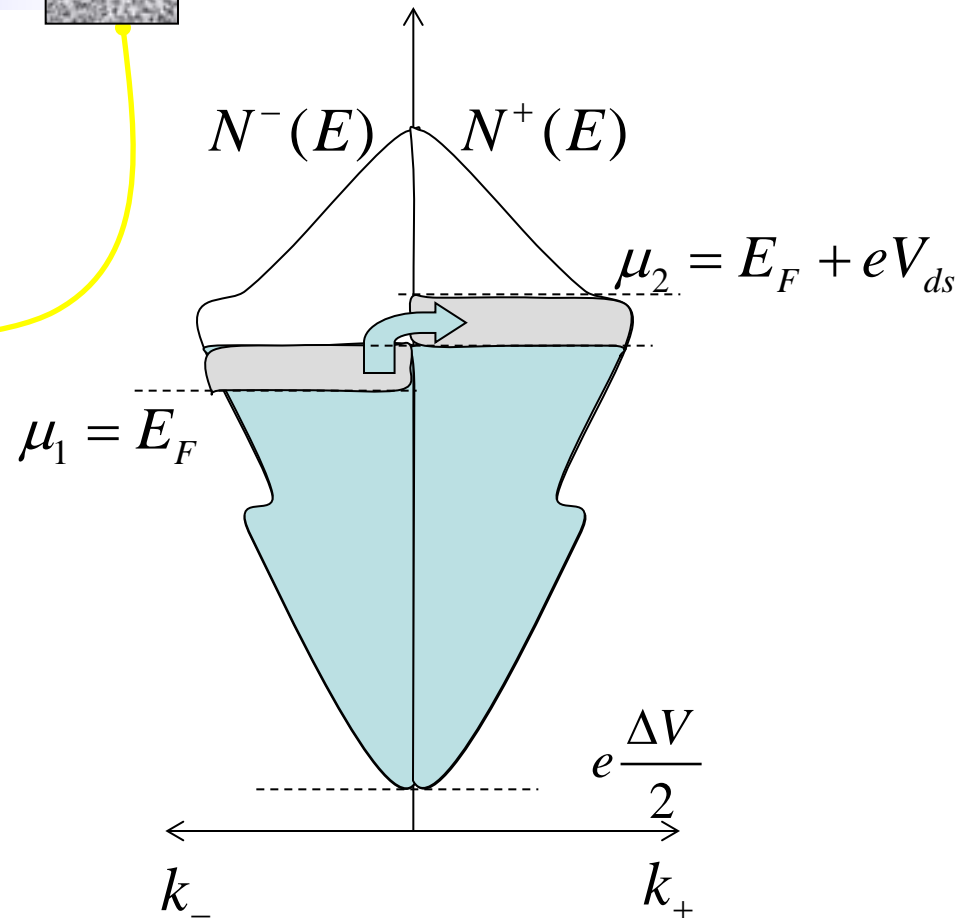
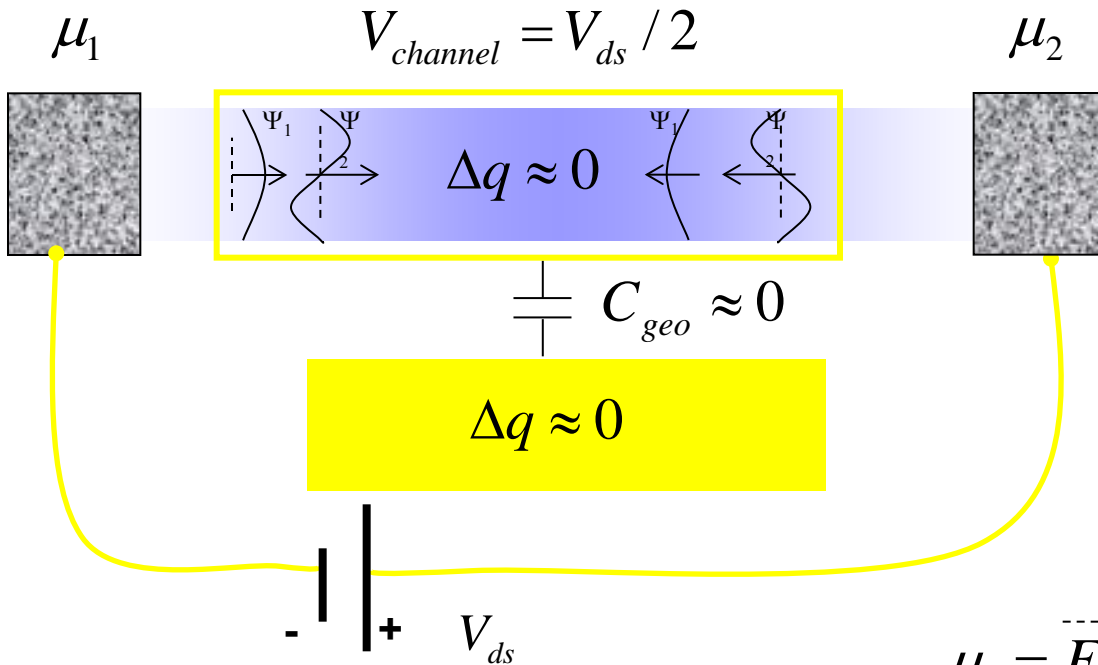

$$\Delta E = \left(N^+(E_F) \times \frac{eV}{2} \right) \times \frac{eV}{2} = \frac{1}{2} L_K I^2$$

$$L_K = \frac{1}{e^2 N(E_F) v_F^2} \propto \frac{1}{N_{modes}}$$

Cas sans interactions

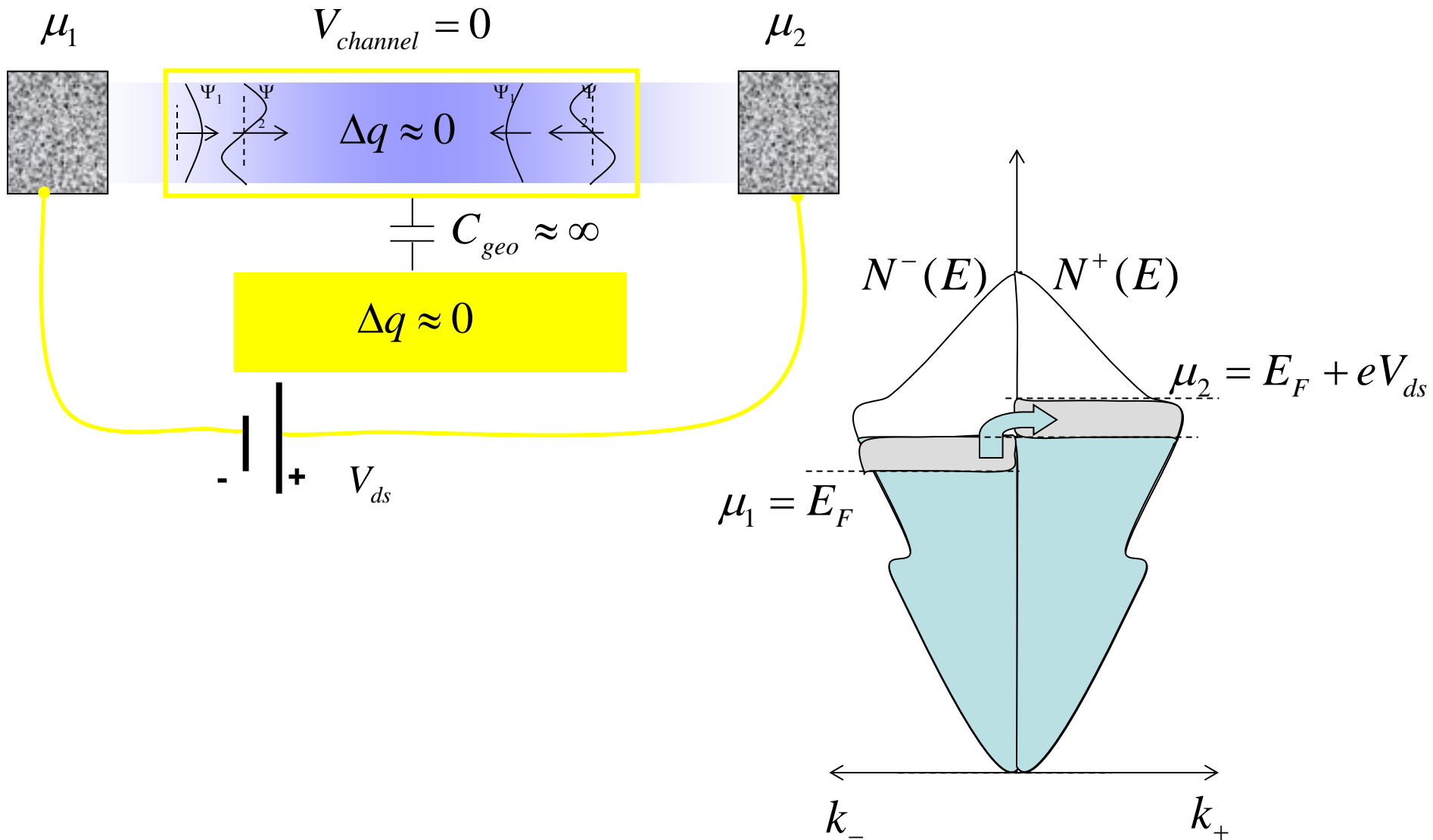

Cas chiral

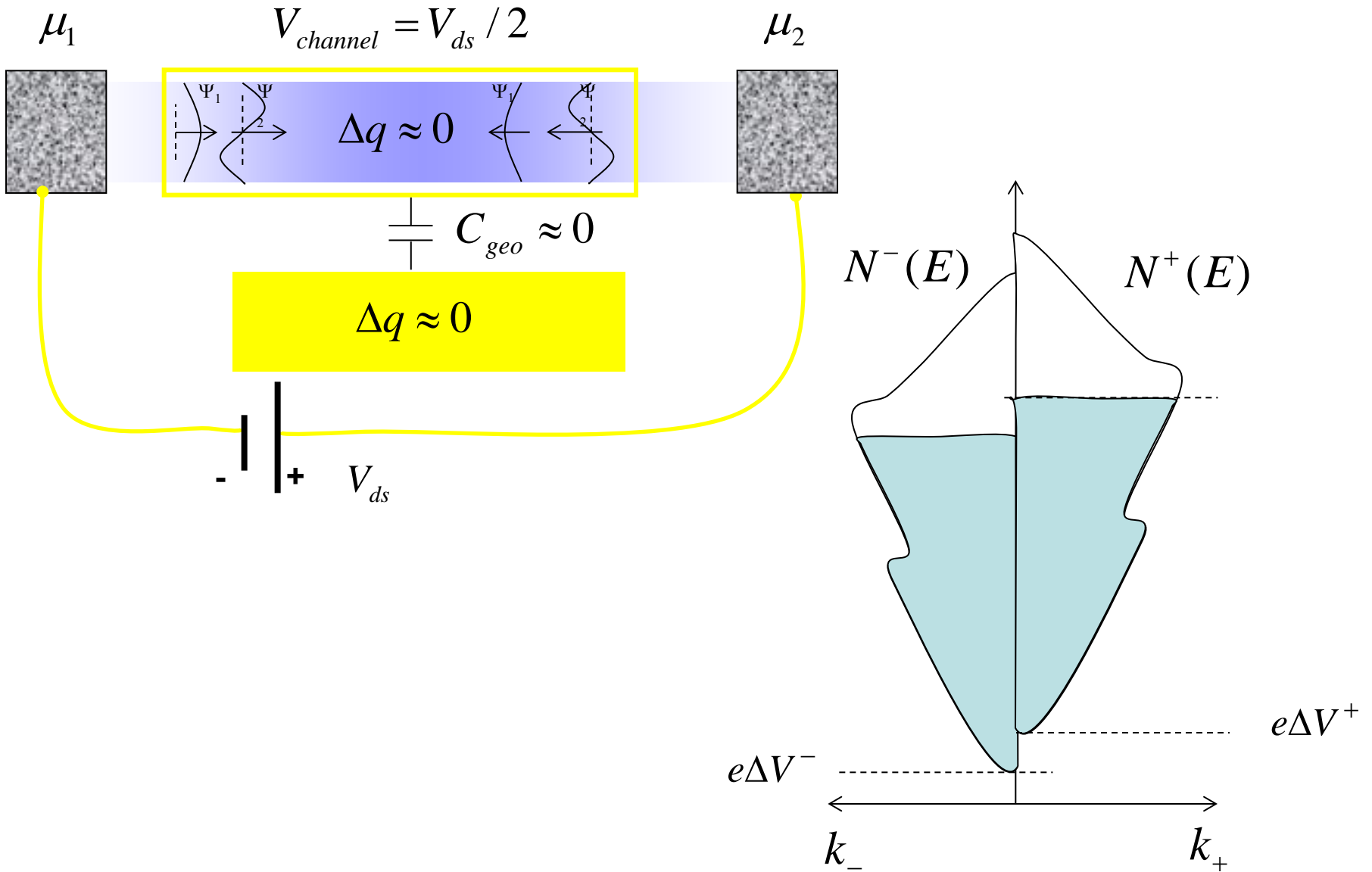

Ordres de grandeur

$$C_Q = \frac{2Ne^2}{h\nu_F} \approx 400 \text{ pF/m} \approx C_{geo}$$

(nanoconducteurs, graphène, nanotubes $N = 4$, $\nu_F = 8 \cdot 10^5$)

$$L_K = \frac{1}{C_Q \nu_F^2} \approx 4 \text{ mH/m} \gg L_{geo}$$

(petit nombre de modes: canaux de bord, nanotubes)

Plan du cours

A. Introduction à la dynamique mésoscopique

1. Introduction
2. Apport des hautes fréquences
3. Mesurables

B. Techniques expérimentales

1. Paramètres de diffusion
2. Montages de mesure de signaux rf faibles

C. Admittance de conducteurs quantiques

1. Relaxation de charge d'une capacité mésoscopiques
2. Inductance mésoscopique d'une barre de Hall
3. Dynamique de transistors à nanotube de carbone

D. Manipuler des électrons uniques

1. Injection d'électrons uniques
2. Vers la détection d'électrons volants

Paramètres de diffusion

Mesures 1-4 ports de paramètres de diffusion

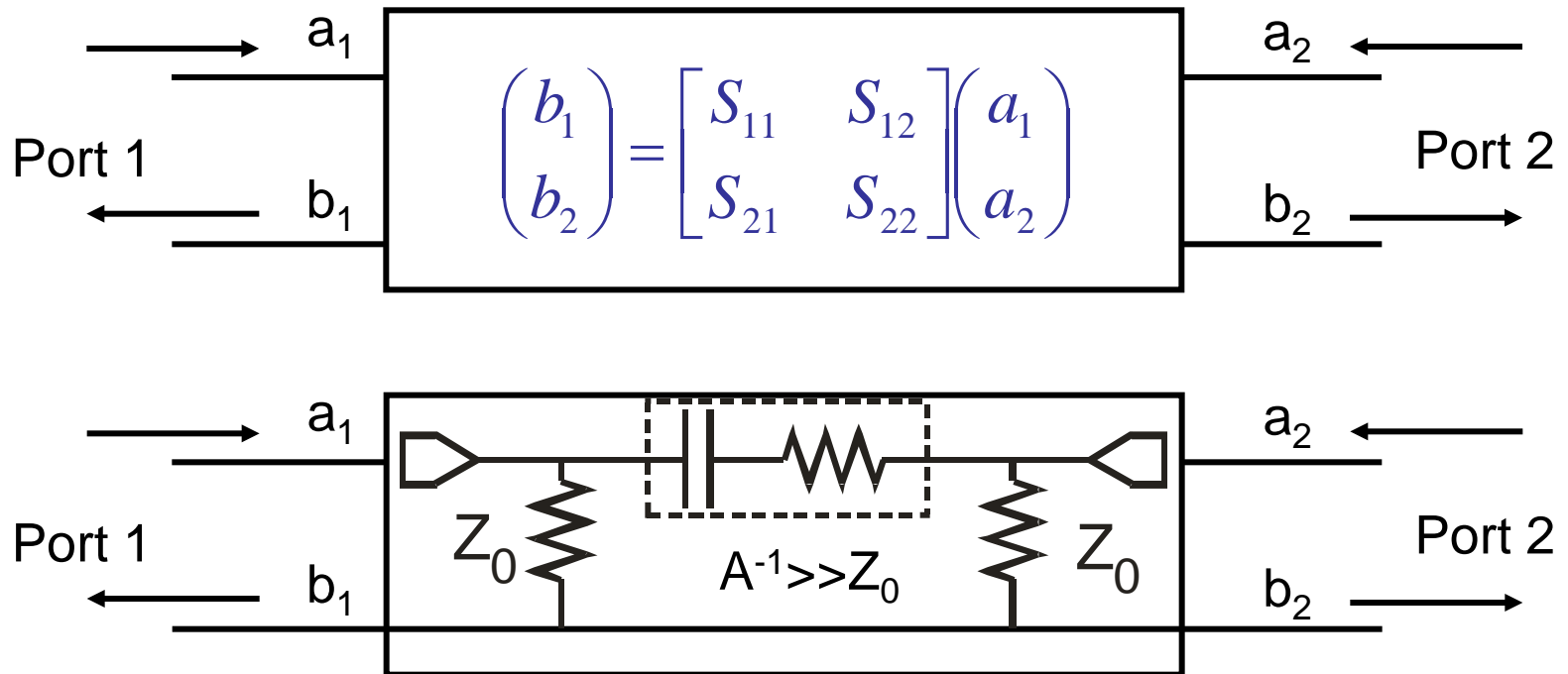

$$S_{11} = \frac{Z - Z_0}{Z + Z_0} \approx -Z_0 A(\omega) / 2$$

$$S_{21} = \frac{Z_0}{Z + Z_0} \approx Z_0 A(\omega) \leq 10^{-3}$$

Mesures par réflectométrie

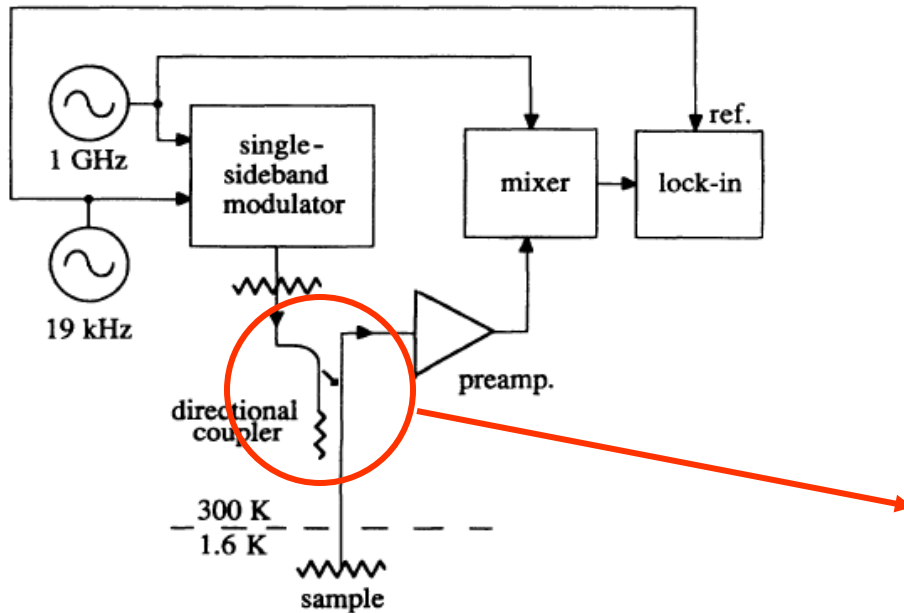

isolation ~ -20 dB
(fuite de 10% en amplitude)

FIG. 2. Schematic diagram of the reflection bridge used for the 1-GHz measurements.

Measurement of the weak-localization complex conductivity in Ag wires, J.B. Pieper, J.C. Price, J.M. Martinis, PRB 45, 3857 (1992).

mesure de transmission en géométrie coplanaire

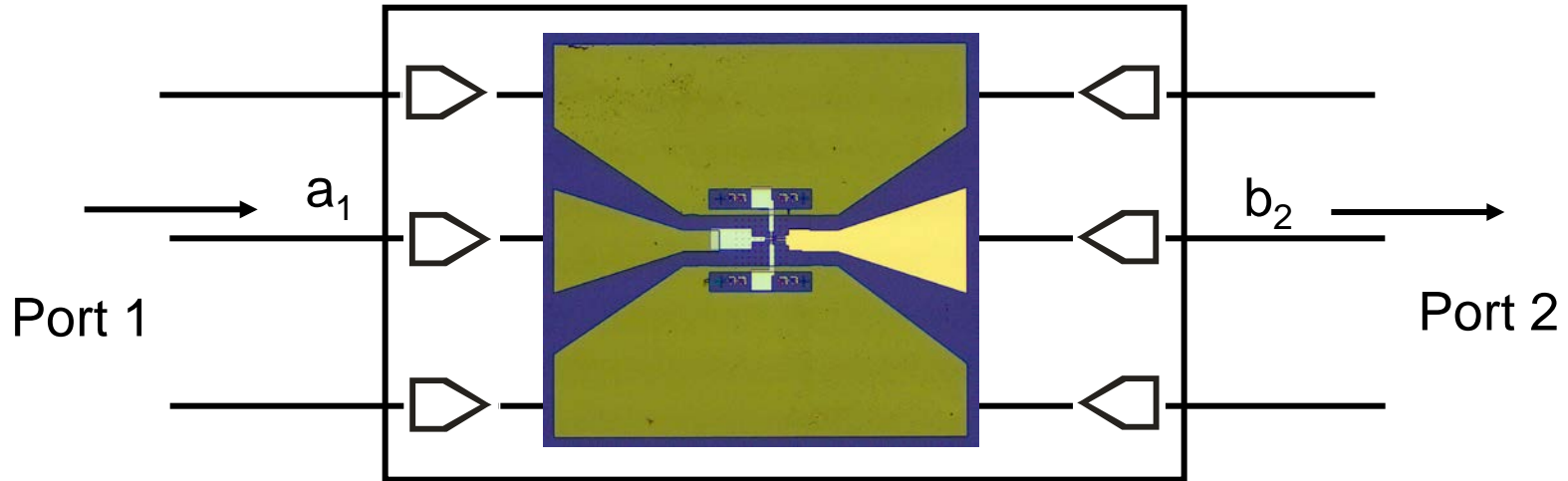

- 60dB isolation in/out @1GHz et signal $S_{21} \approx Z_0 A(\omega) \sim 10^{-3} \geq \text{parasite !}$

Appareils commerciaux (300K mais aussi 4K)

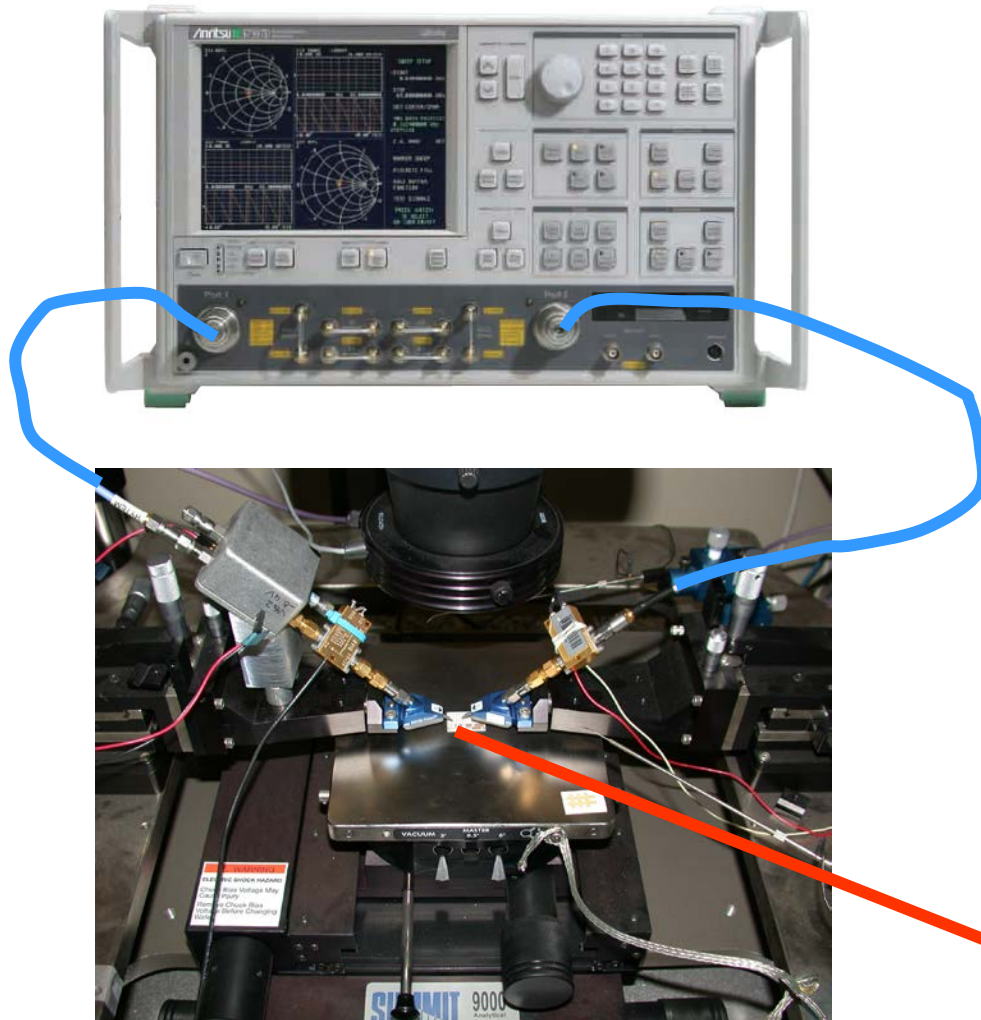

Microwave engineering, D.M. Pozar, ed.: J. Wiley and Sons, 3^{ème} édition,

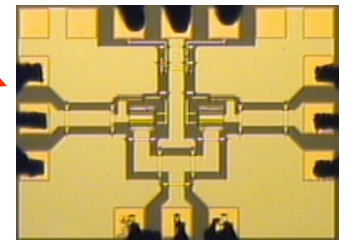

Mesures en boîtier

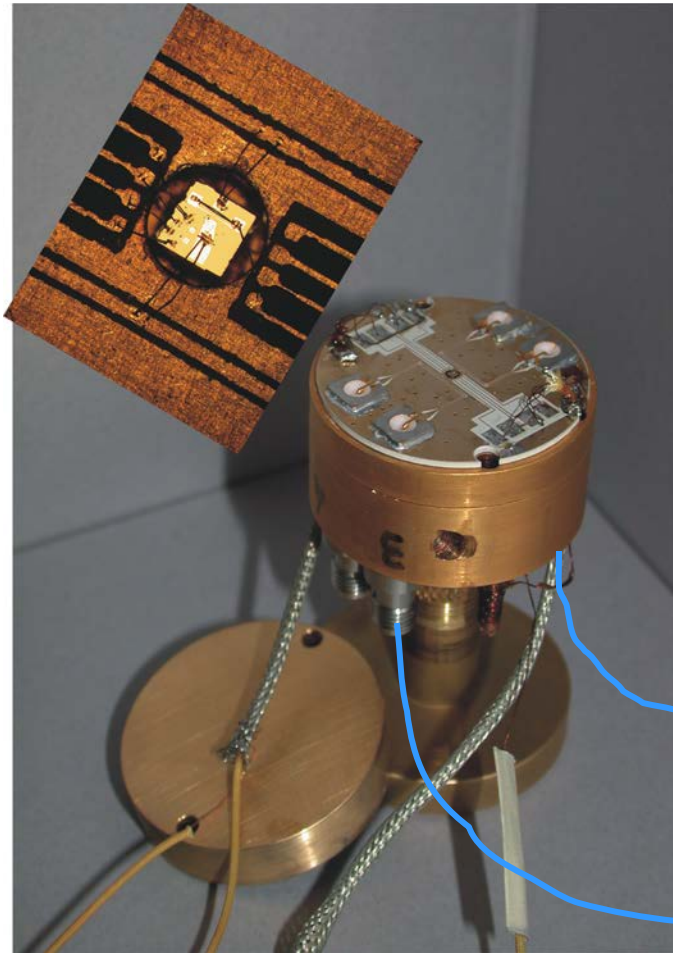

Microwave engineering, D.M. Pozar, ed.: J. Wiley and Sons, 3^{ème} édition,

Montages de mesure admittance

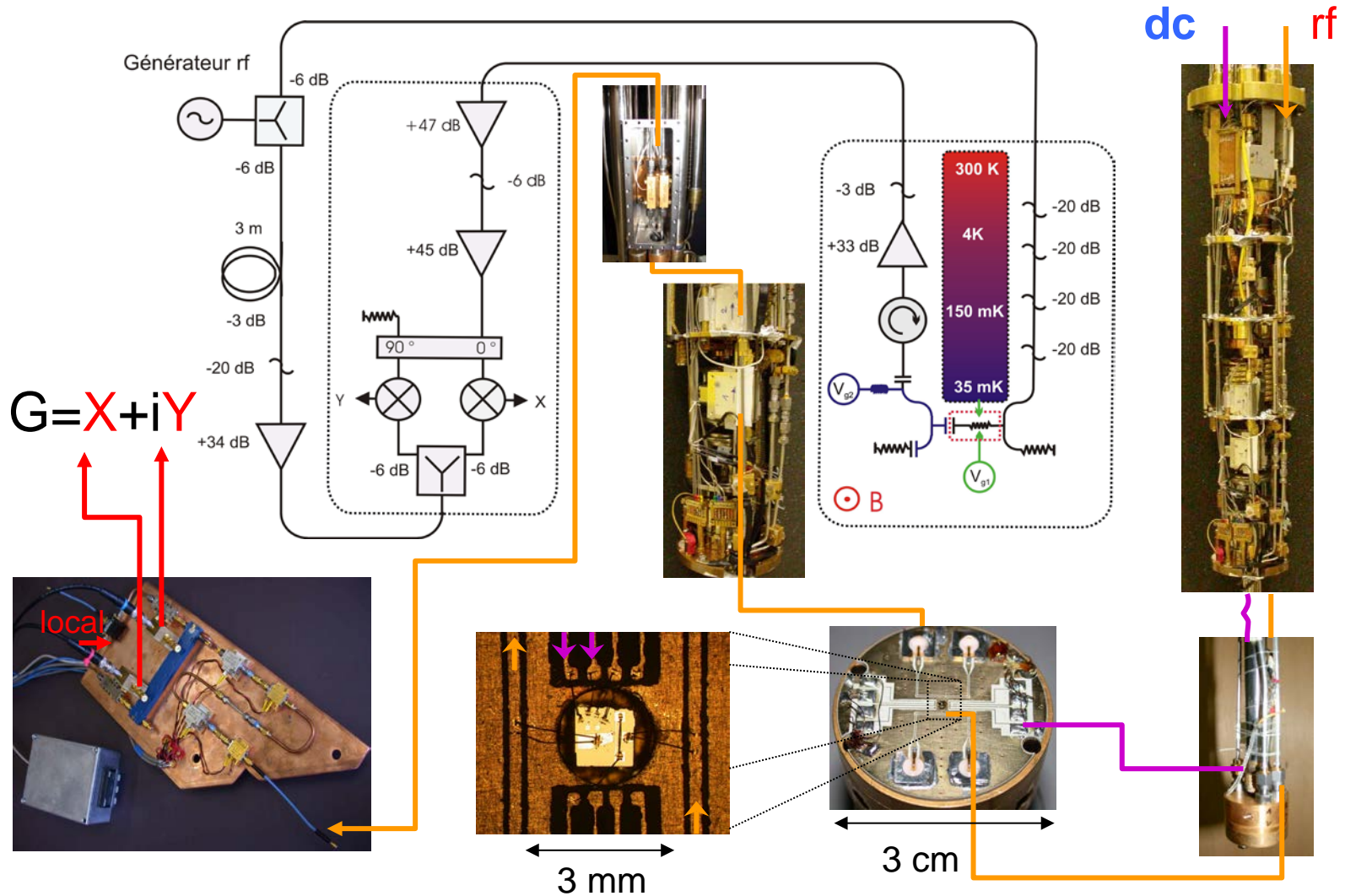

Montages de mesure de bruit

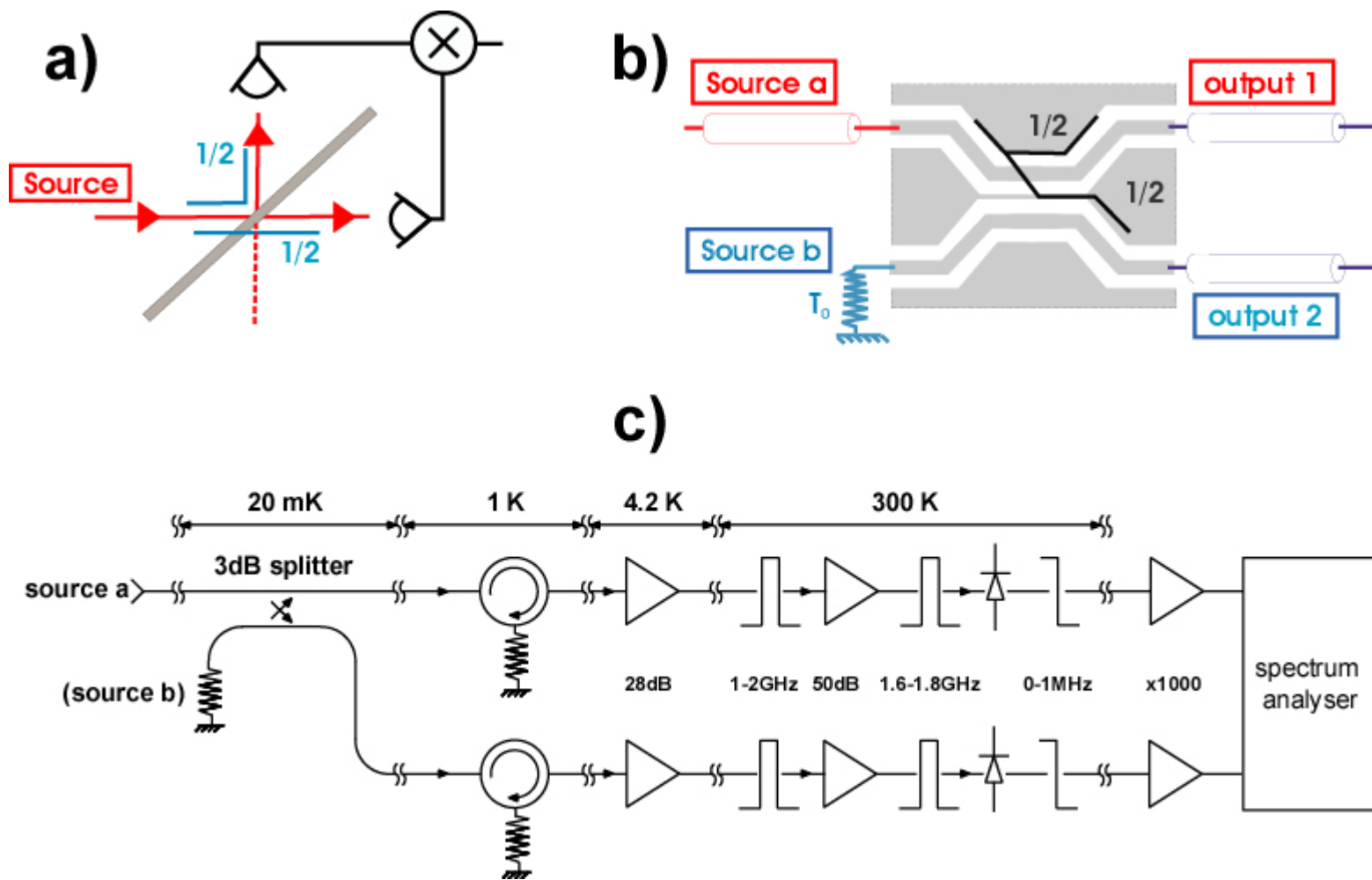

le problème de résolution

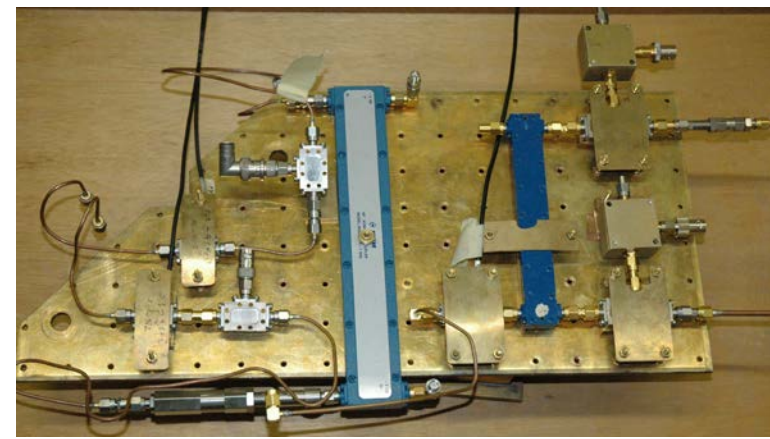
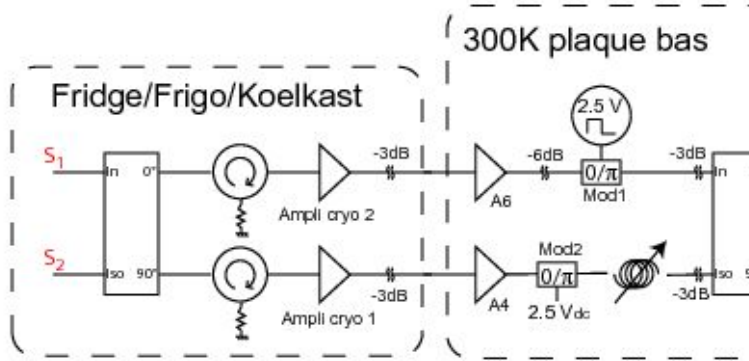
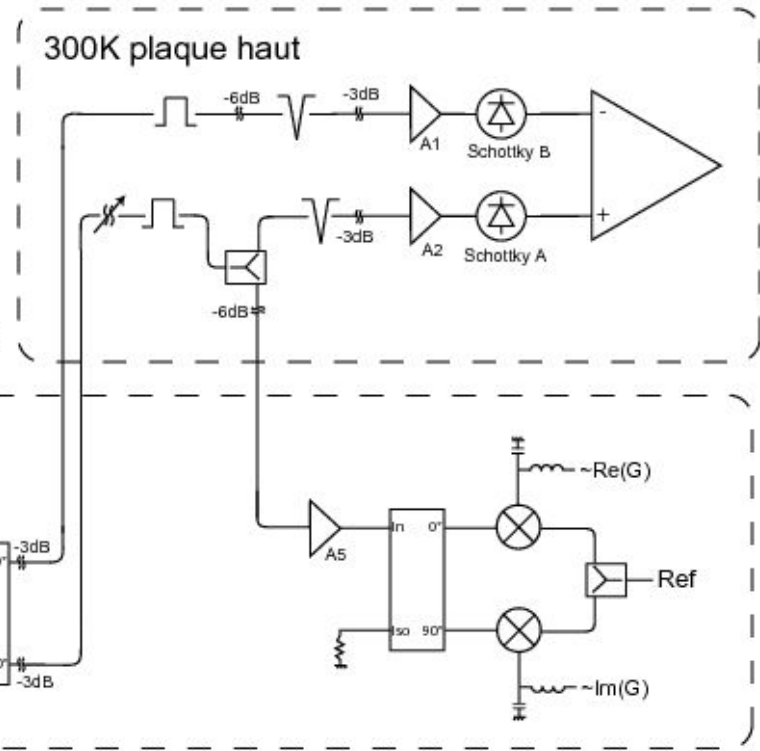
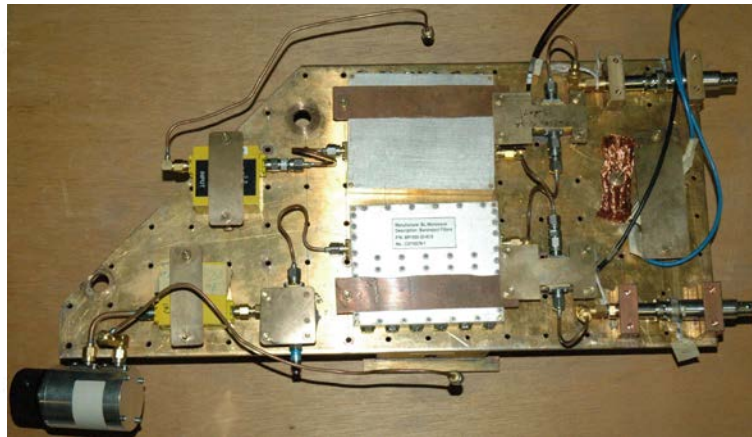

$$\delta T_N = \frac{T_N}{\sqrt[4]{\tau \Delta f}} \approx \frac{5 \text{ K}}{\sqrt[4]{10^3 \text{ s} \times qqs 10^8 \text{ Hz}}} = 10 \mu\text{K} !!!$$

$$\delta T_S \leq 2e(ef) \frac{Z_0}{4k} \approx \frac{5 \text{ K}}{\sqrt[4]{10^3 \times qqs 10^8}} = 45 \mu\text{K} !!$$

Adaptation impedance : ligne quart d'onde $f > 1 \text{ GHz}$

$$\left(Z_{\text{sample}} \geq \frac{h}{e^2} \right) \gg \gg \left(Z_{\text{vide}} = \sqrt{\frac{L_{\text{vide}}}{C_{\text{vide}}}} = \sqrt{\frac{\mu_0}{\epsilon_0}} \approx 377 \Omega \right) \geq Z_{\text{coax}} = 50 \Omega$$

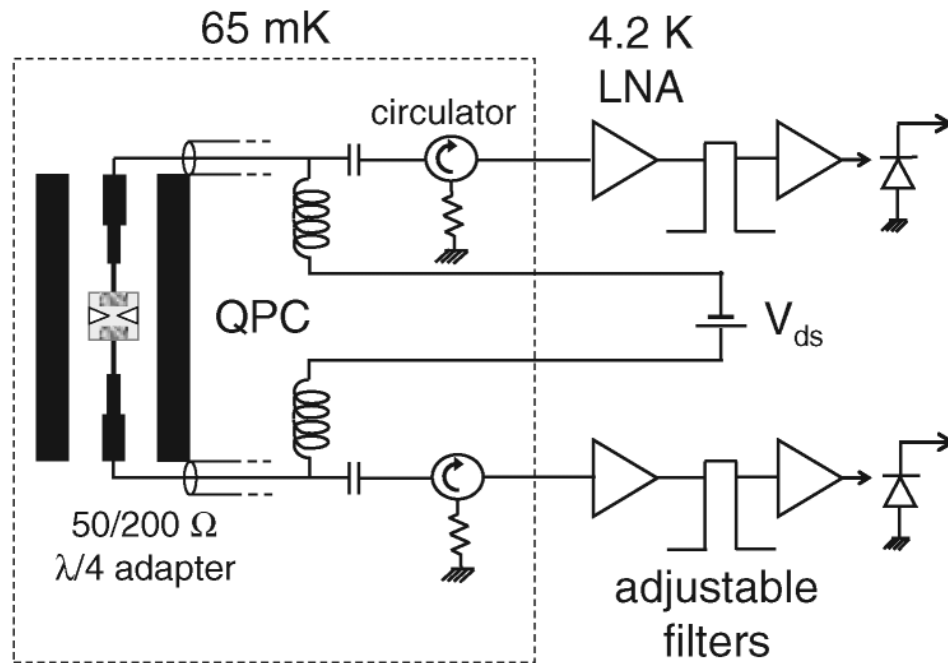

4-8 GHz (Saclay)

1-4 GHz (ENS)

Experimental Test of the High-Frequency Quantum Shot Noise Theory in a Quantum Point Contact
 E. Zakka-Bajjani, J. Segala, F. Portier, P. Roche, and D. C. Glatthli, A. Cavanna, Y. Jin, PRL 99, 236803 (2007).

Adaptation impedance : transformateur $f < 1$ GHz

Ligne 50 ohms NT-FET Ligne 200 ohms Ligne 50 ohms

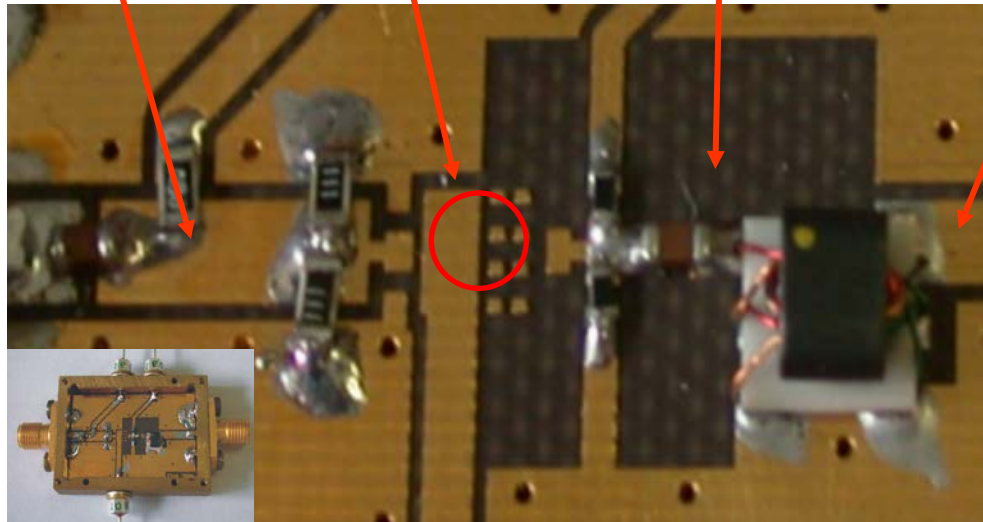

J. Chaste, Thèse UPMC, MESO

Plan du cours

A. Introduction à la dynamique mésoscopique

1. Introduction
2. Apport des hautes fréquences
3. Mesurables

B. Techniques expérimentales

1. Paramètres de diffusion
2. Montages de mesure de signaux rf faibles

C. Admittance de conducteurs quantiques

1. Relaxation de charge d'une capacité mésoscopiques
2. Inductance mésoscopique d'une barre de Hall
3. Dynamique de transistors à nanotube de carbone

D. Manipuler des électrons uniques

1. Injection d'électrons uniques
2. Vers la détection d'électrons volants

Relaxation de charge d'une capacité mésoscopique

Relaxation de charge d'une capacité mésoscopique

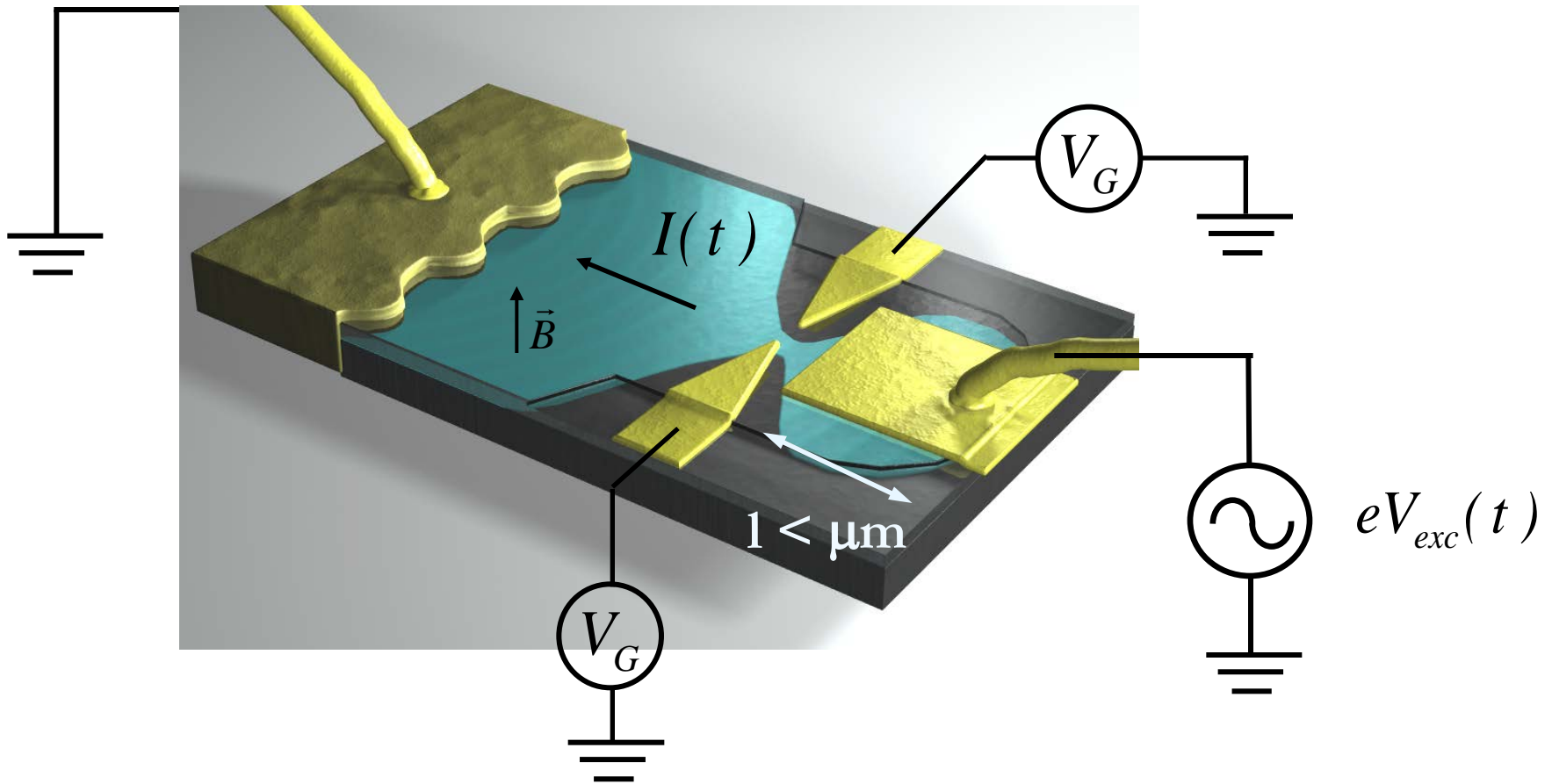

Thèse J. Gabelli

Violation of Kirchhoff's Laws for a Coherent RC Circuit, J. Gabelli, et al. MESO, Science 313, 499 (2006), *ibid* (Physica B 2006).

modèle scattering : 1 mode à 1D

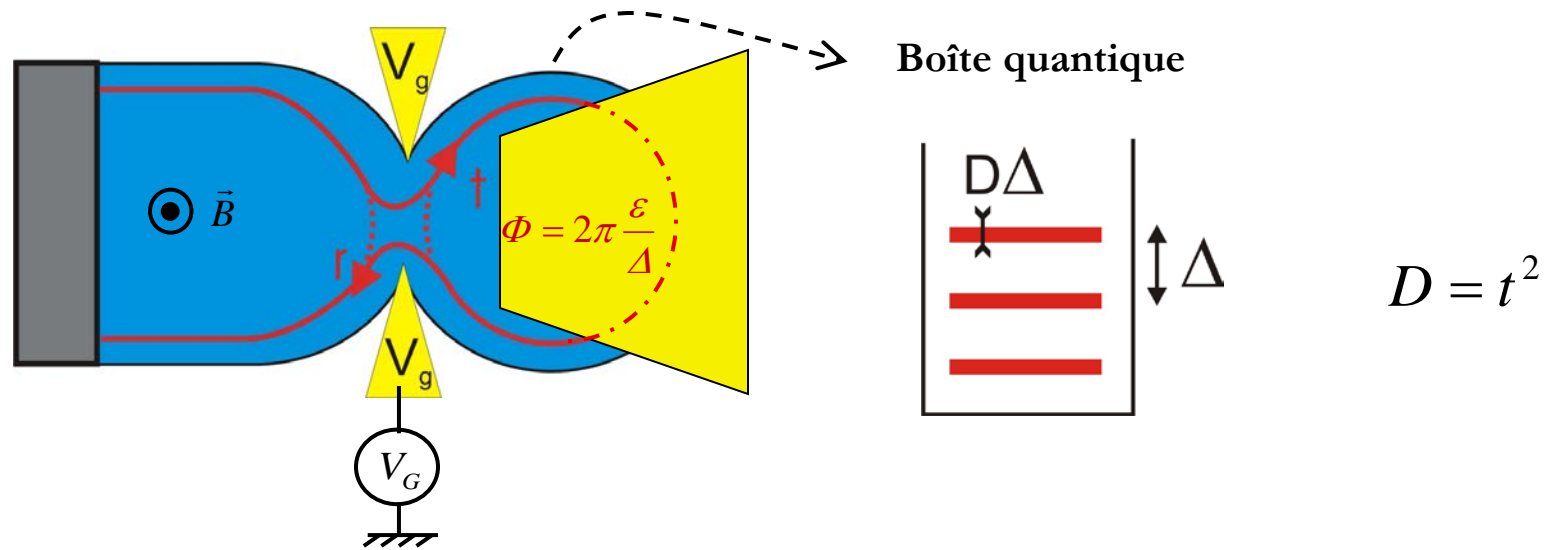

$$\begin{pmatrix} s(\varepsilon)a_1 \\ b_0 \end{pmatrix} = \begin{bmatrix} r & -t \\ t & r \end{bmatrix} \begin{pmatrix} a_1 \\ e^{i\varphi}b_0 \end{pmatrix} \Rightarrow s(\varepsilon) = \frac{r - e^{i\varphi}}{1 - re^{i\varphi}} \quad \text{avec} \quad \left(\varphi = 2\pi \frac{\varepsilon}{\Delta}\right)$$

Admittance au deuxième ordre en fréquence

$$g(\omega) = \frac{\delta I}{\delta V - \delta U} = \frac{e^2}{h} \int d\varepsilon \left(1 - s^+(\varepsilon)s(\varepsilon + \hbar\omega)\right) \frac{f(\varepsilon) - f(\varepsilon + \hbar\omega)}{\hbar\omega}$$

$$g(\omega) = \frac{e^2}{h} \int d\varepsilon \left[s^+ \frac{ds}{d\varepsilon} \hbar\omega + \left(s^+ \frac{ds}{d\varepsilon} \right)^2 \frac{(\hbar\omega)^2}{2} \right] \frac{df}{d\varepsilon}$$

$$g(\omega) = -i\omega \int d\varepsilon \left[e^2 N(\varepsilon) \right] \frac{df}{d\varepsilon} + \int d\varepsilon \left[\frac{h}{2e^2} \left(e^2 N(\varepsilon) \right)^2 \omega^2 \right] \frac{df}{d\varepsilon}$$

$$g(\omega) = -iC_Q\omega + (C_Q\omega)^2 R_q$$

Dynamic conductance and the scattering matrix of small conductors, M. Büttiker, A. Prêtre, H. Thomas, PRL70, 4114 (1993).
Dynamic admittance of mesoscopic conductors: Discrete-potential model, A. Prêtre, H. Thomas, M. Büttiker, PRB54, 8130 (1996).

Modèle unidimensionnel

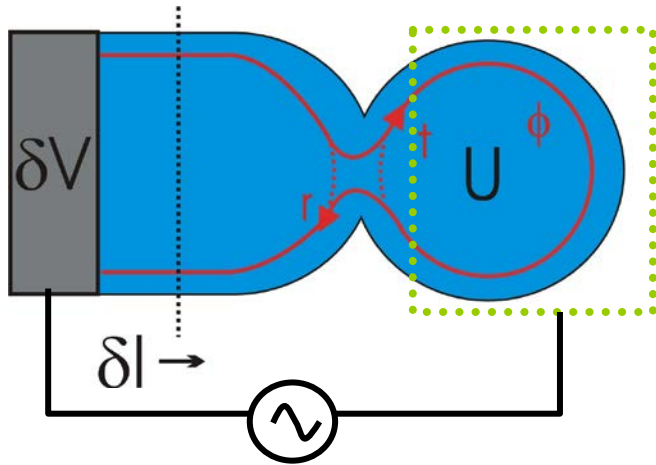
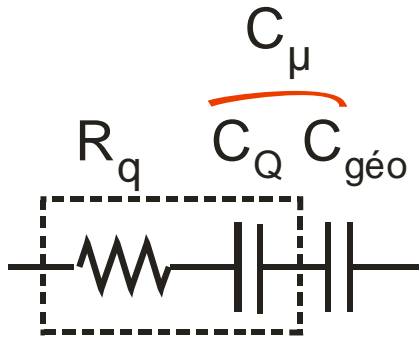

$$g(\omega) = \frac{\delta I}{\delta V - \delta U} = \frac{\delta I}{\delta V - \delta I / jC_{\Sigma}\omega}$$

$$\frac{1}{G(\omega)} = \frac{1}{g(\omega)} + \frac{1}{jC_{\Sigma}\omega}$$

$$= \frac{h}{2e^2} + \frac{1}{jC_Q\omega} + \frac{1}{jC_{\Sigma}\omega} = \frac{h}{2e^2} + \frac{1}{jC_{\mu}\omega}$$

$$C_Q = \int d\varepsilon \left[e^2 N(\varepsilon) \right] \frac{df}{d\varepsilon} \xrightarrow{T \rightarrow 0} e^2 N(\varepsilon)$$

$$R_q = \frac{\int d\varepsilon \left[\frac{h}{2e^2} (e^2 N(\varepsilon))^2 \right] \frac{df}{d\varepsilon}}{\left[\int d\varepsilon \left[e^2 N(\varepsilon) \right] \frac{df}{d\varepsilon} \right]^2} \xrightarrow{T \rightarrow 0} \frac{h}{2e^2}$$

C_q

Régime cotunneling ($kT \ll D\Delta$)

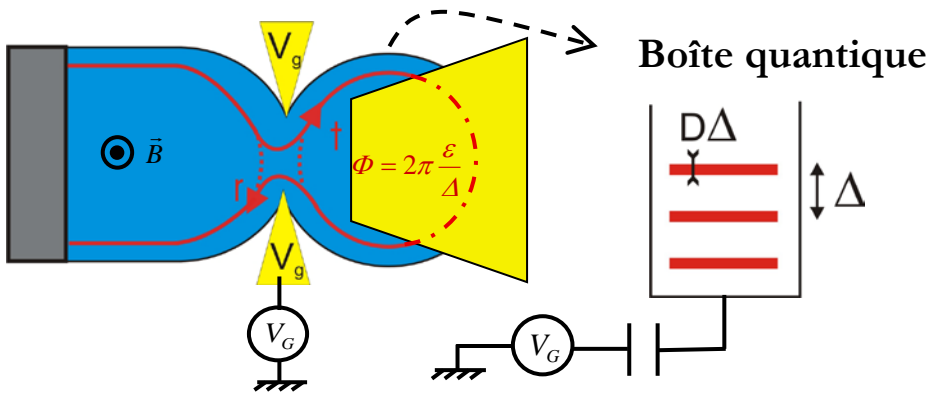

$$D = \left(1 + \exp - \frac{V_g - V_1}{\Delta V_0} \right)^{-1}$$

$$N(\epsilon) = \frac{1}{\Delta} \frac{1 - r^2}{1 - 2r \cos(2\pi\epsilon / \Delta) + r^2}$$

$$C_Q = e^2 N(\epsilon) \quad ; \quad R_q = \frac{h}{2e^2} = \text{cte} \quad ; \quad \tau_q = R_q C_Q = \frac{hN(\epsilon)}{2}$$

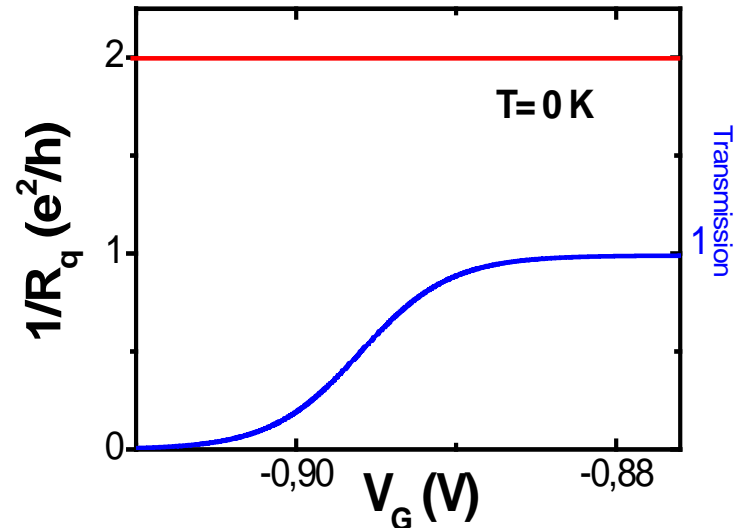
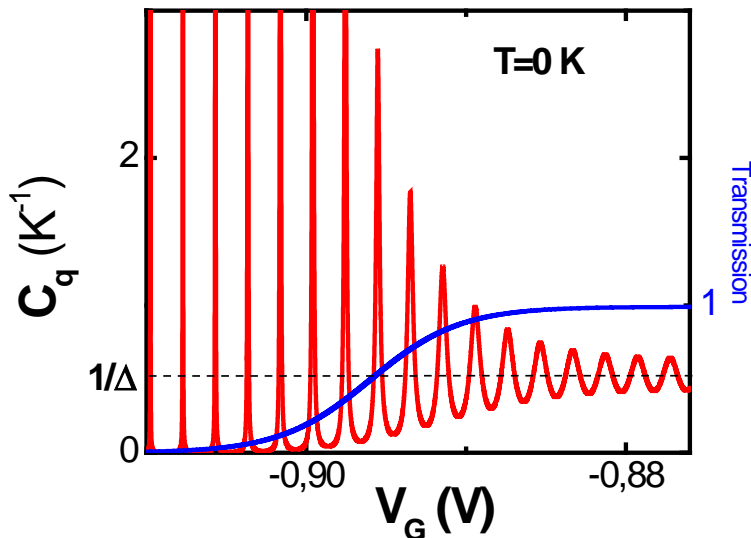

Régime séquentiel ($kT \gg D\Delta$)

$$\tilde{C}_Q = \int d\varepsilon \frac{e^2}{\Delta} \frac{1-r^2}{1-2r \cos(2\pi\varepsilon/\Delta) + r^2} \frac{df}{d\varepsilon} = \frac{e^2}{4kT \cosh^2(\delta\varepsilon/2kT)}$$

$$\frac{1}{\tilde{R}_q} = \left(\frac{D\Delta}{h} \right) \times \frac{e^2}{4kT \cosh^2(\delta\varepsilon/2kT)} \quad ; \quad \tau = \tilde{R}_q \tilde{C}_Q = \frac{h}{D\Delta}$$

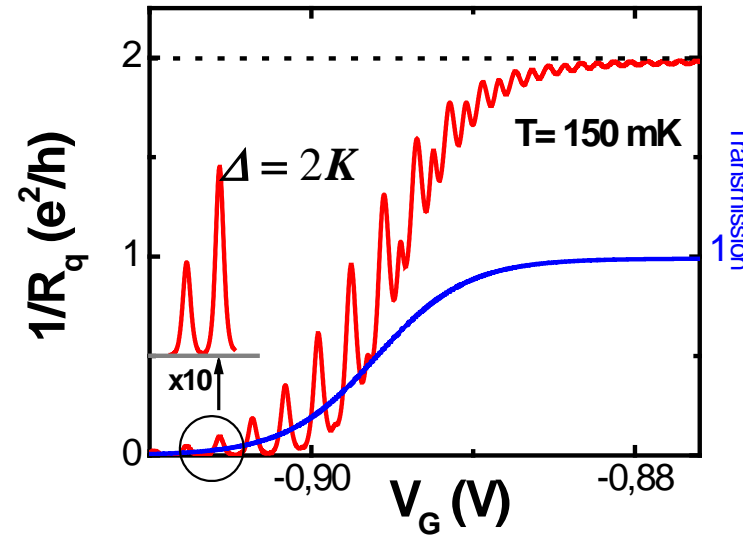
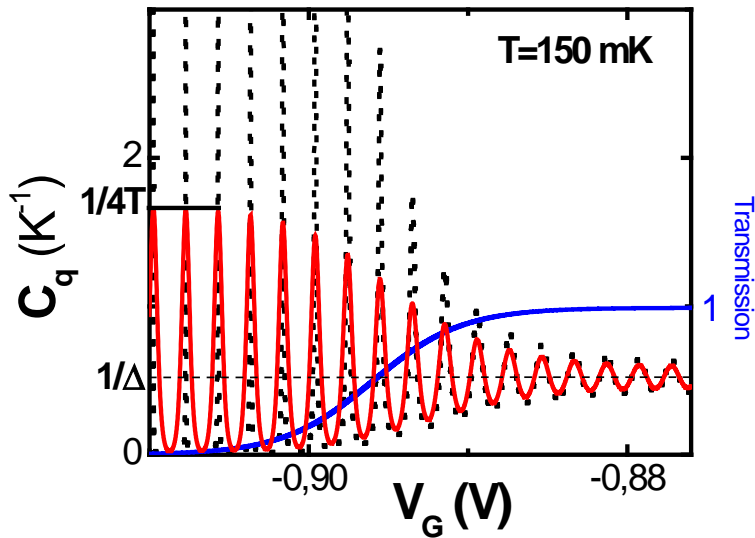

résumé

régime cohérent ($kT \ll D\Delta$)

$$C_Q = e^2 N(\varepsilon) \quad ; \quad R_q = \frac{h}{2e^2} = \text{cte} \quad \left(< R_{\text{Landauer}} = \frac{h}{De^2} \right)$$

$\tau_Q = R_q C_Q = \frac{hN(\varepsilon)}{2}$ est donné par le temps de résidence de l'électron dans le point quantique

régime brouillage thermique ($kT \geq D\Delta$)

$$\tilde{C}_Q = \frac{e^2}{4kT \cosh^2(\delta\varepsilon/2kT)} \quad ; \quad \frac{1}{\tilde{R}_q} = \frac{D\Delta}{h} \frac{e^2}{4kT \cosh^2(\delta\varepsilon/2kT)} \quad ;$$

$\tau = \tilde{R}_q \tilde{C}_Q = \frac{h}{D\Delta}$ est donné par la durée de vie de l'électron dans le point quantique

Mesoscopic charge relaxation, S.E. Nigg, R. Lopez, M. Büttiker, PRL 97, 206804 (2006) ; Quantum to classical transition of the charge relaxation resistance of a mesoscopic capacitor, S.E. Nigg, M. Büttiker, PRB 77, 085312 (2008)

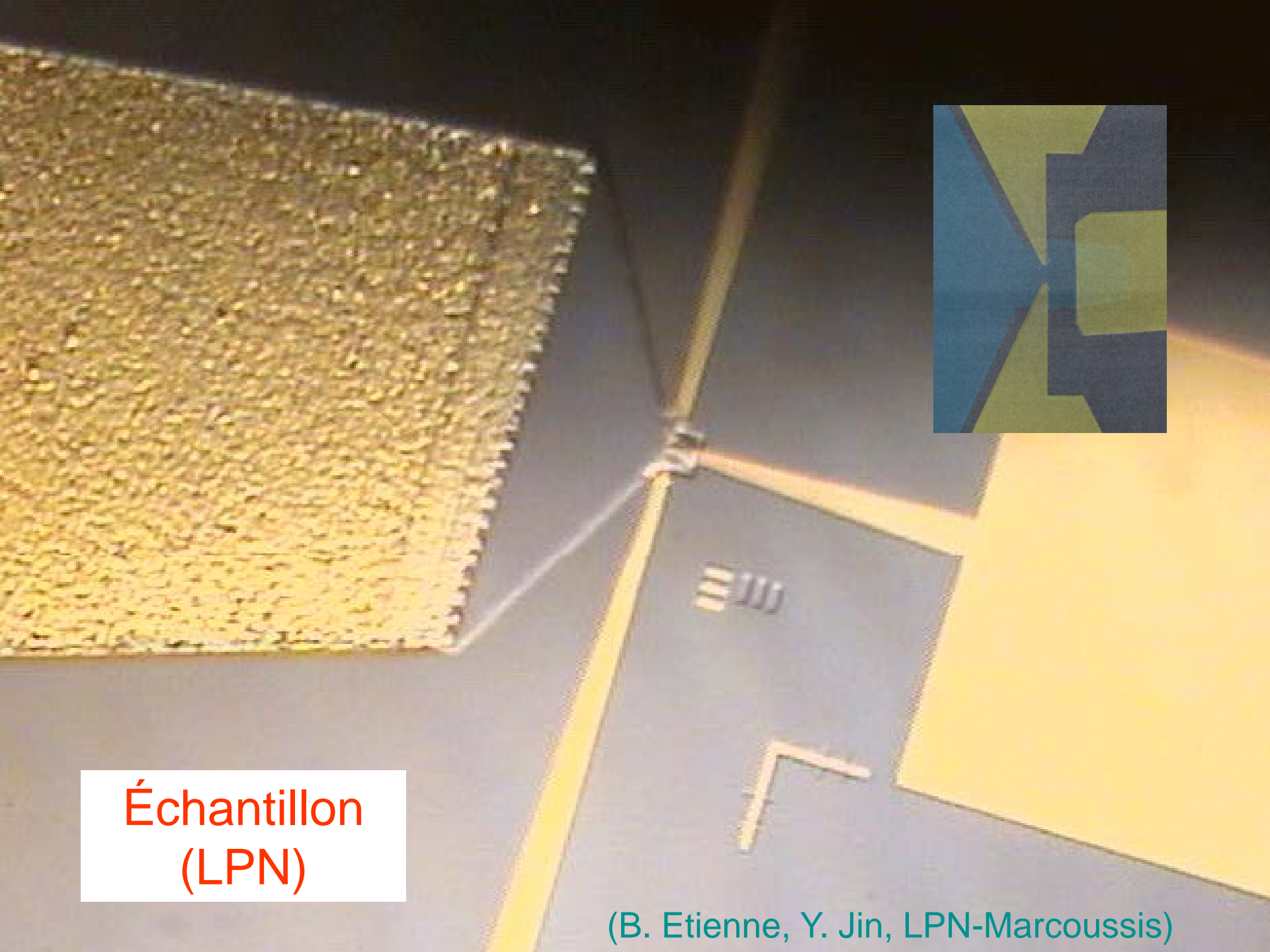

Échantillon
(LPN)

(B. Etienne, Y. Jin, LPN-Marcoussis)

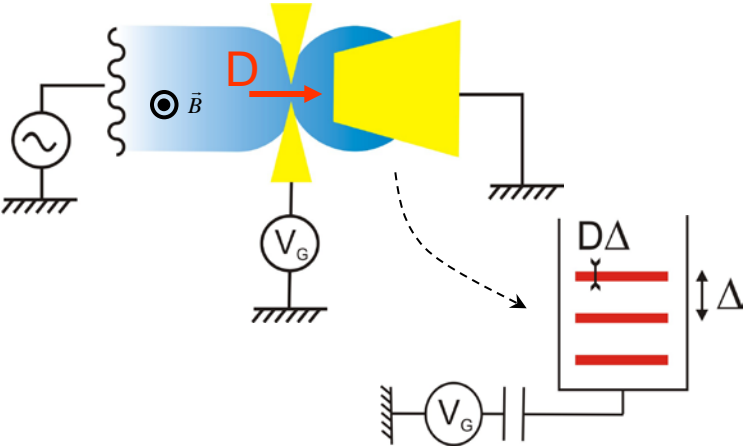

conductance

$f=1,5 \text{ GHz}, T = 30 \text{ mK}$

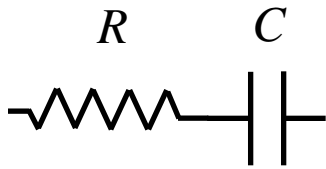

$$\text{Im}(G) = \frac{C\omega}{1 + (RC\omega)^2}$$

$$\text{Re}(G) = \frac{R(C\omega)^2}{1 + (RC\omega)^2}$$

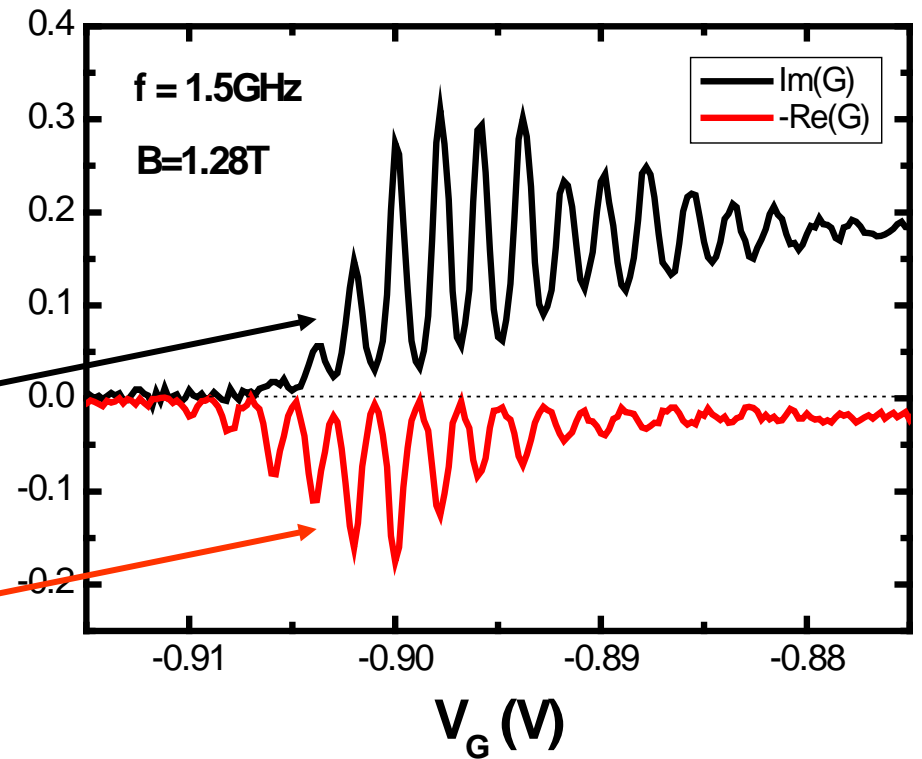

Capacitif cohérent à forte transmission

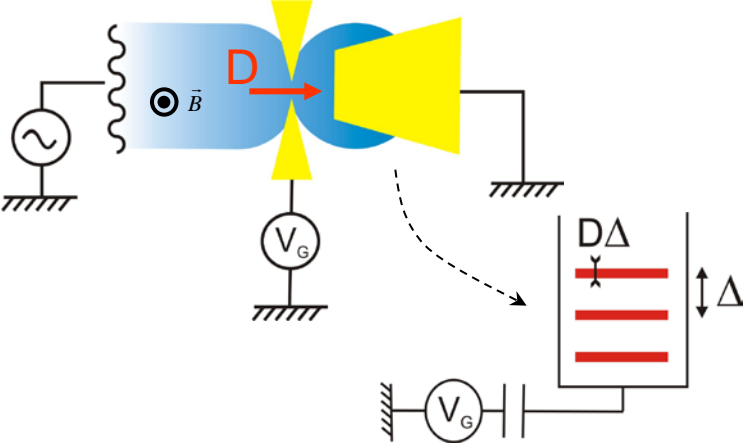

$f=1,5 \text{ GHz}, T = 30 \text{ mK}$

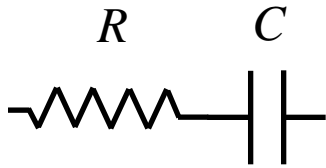

$$\text{Im}(G) = \frac{C\omega}{1 + (RC\omega)^2}$$

$$\text{Re}(G) = \frac{R(C\omega)^2}{1 + (RC\omega)^2}$$

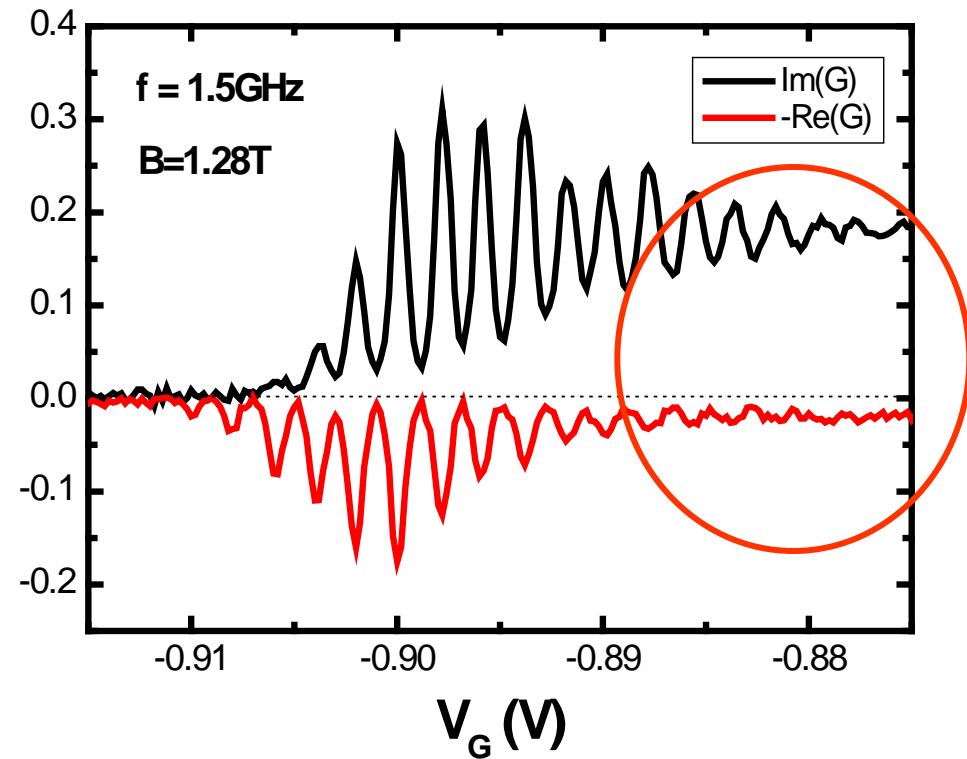

0 $\xrightarrow{\text{D (transmission)}}$ 1

résistif séquentiel à faible transmission

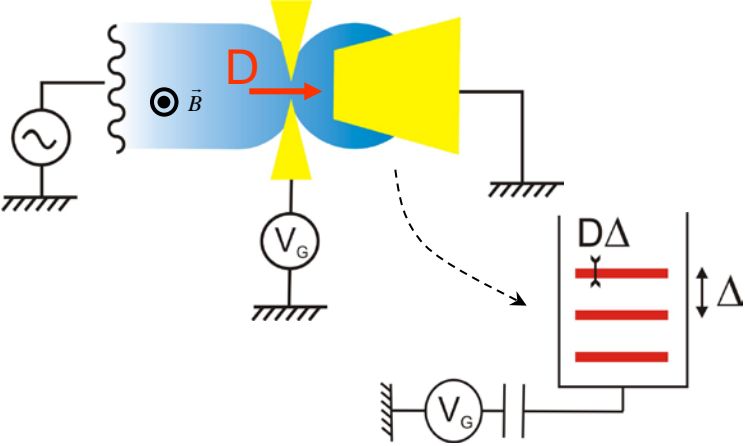

$f=1,5 \text{ GHz}, T = 30 \text{ mK}$

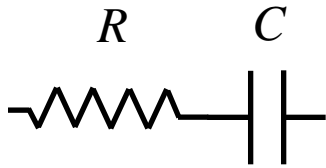

$$\text{Im}(G) = \frac{C\omega}{1 + (RC\omega)^2}$$

$$\text{Re}(G) = \frac{R(C\omega)^2}{1 + (RC\omega)^2}$$

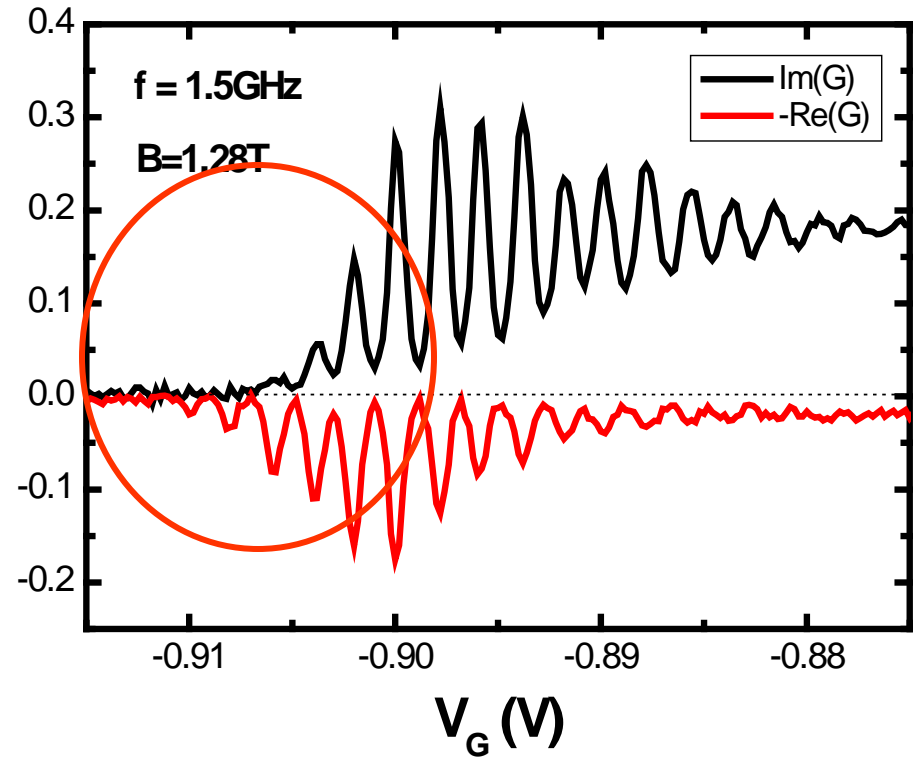

Calibration du couplage à la grille

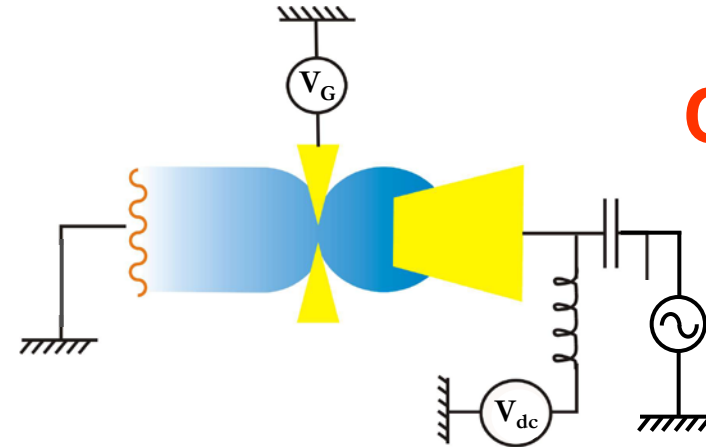

Régime de basse transmission

Largeur des pics $k_B T$

Distance entre pics $\delta V_{dc} \equiv e^2/C_\mu$

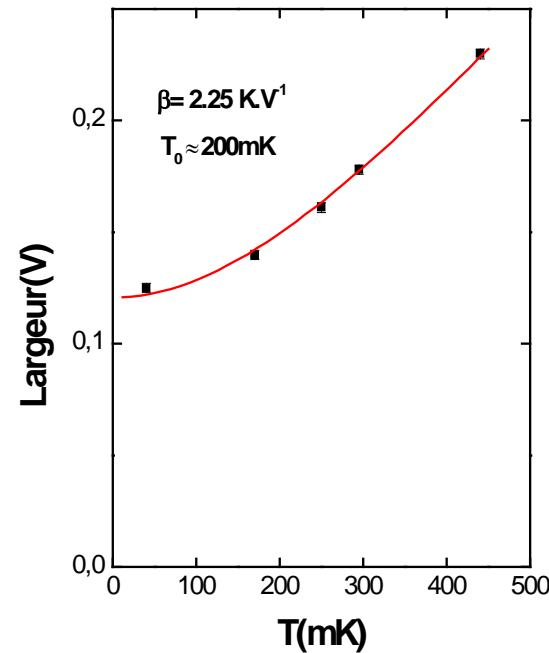
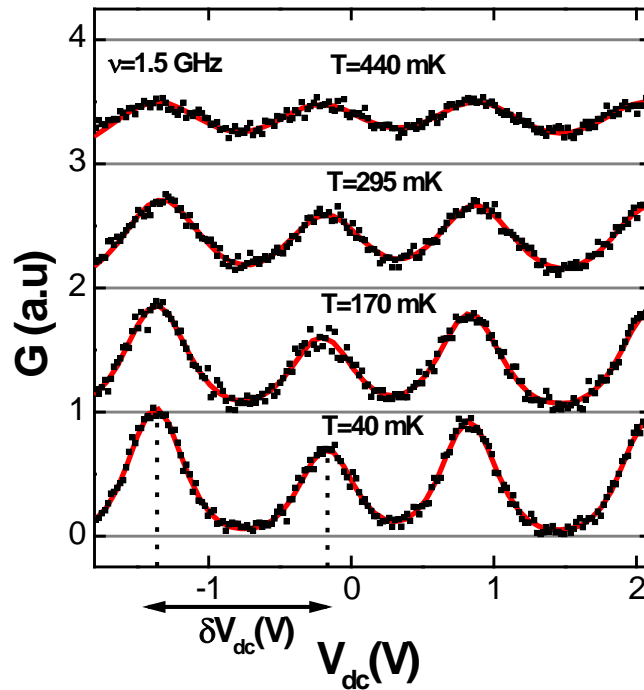

$$\frac{e^2}{C_\mu} = 2.5 K$$

$$C_\mu = 0.75 \text{ fF}$$

Capacité mésoscopique et résistance de relaxation de charge

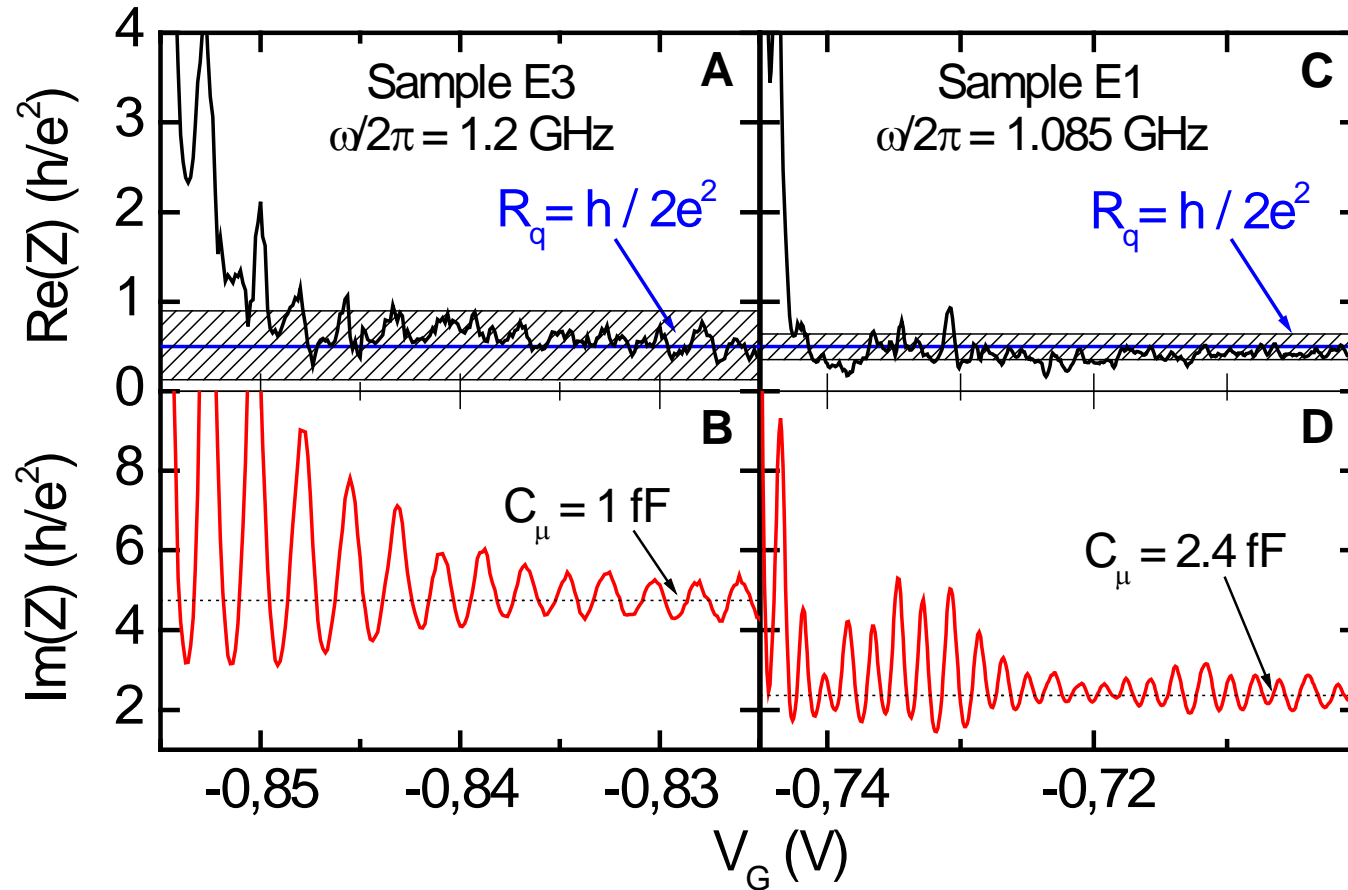

Violation of Kirchhoff's Laws for a Coherent RC Circuit, J. Gabelli et MESO, Science. 313, 499 (2006)

A Quantum Mesoscopic RC Circuit Realized in a 2D Electron Gas, J Gabelli, et MESO, Physica E, **34**, 576 (2006)

Comparaison avec le modèle 1D

$$\frac{e^2}{C_\mu} = 2.5K$$

$$\Delta = 2K$$

$$\frac{e^2}{C} = 0.5K$$

fit using: $D(V_G)$

$$D(V_G) = \frac{1}{1 + e^{-\frac{V_G - V_0}{\Delta V_0}}}$$

$$V_0 = -896mV$$

$$\Delta V_0 = 2.9mV$$

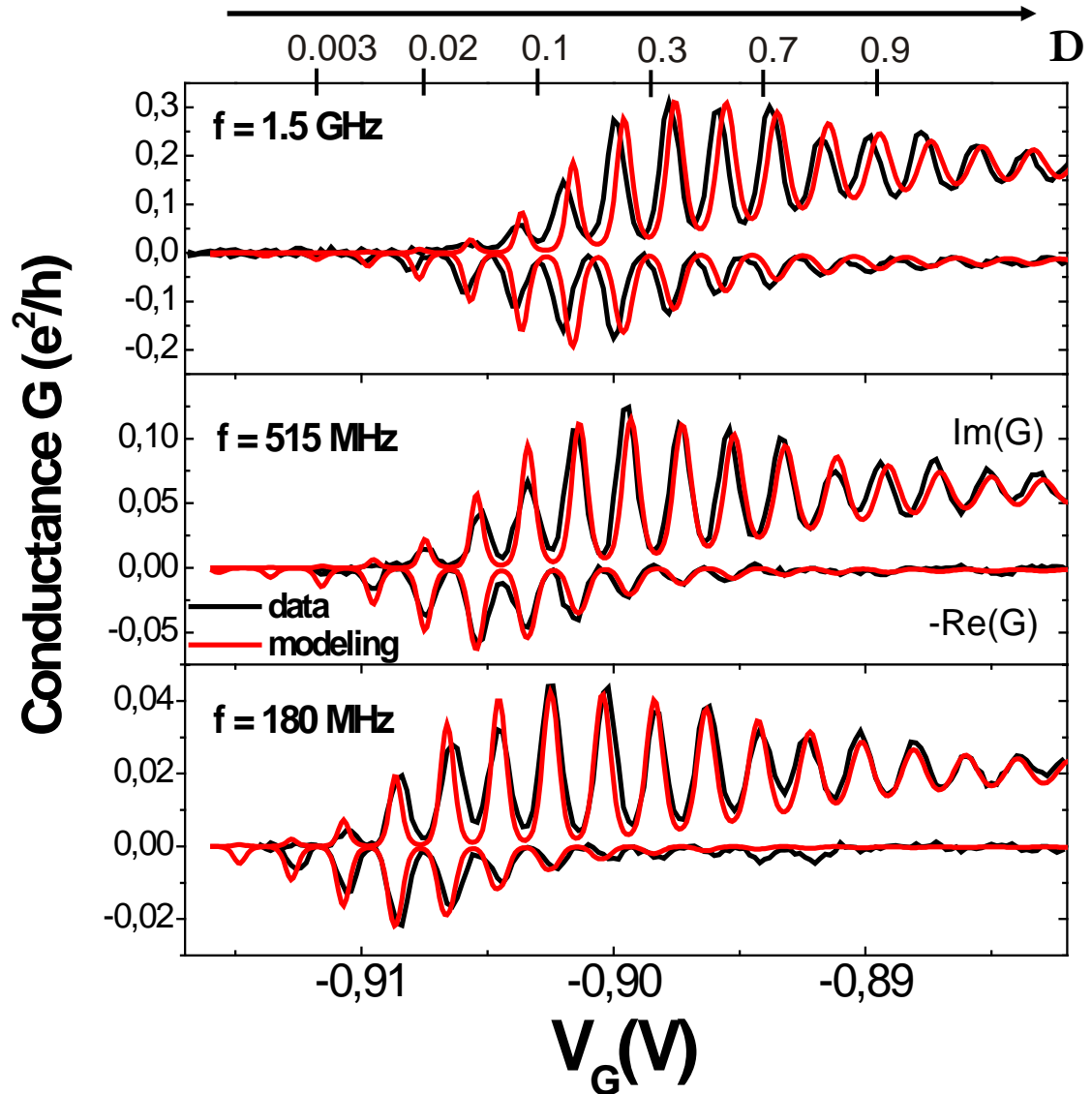

Inductance mésoscopique d'une barre de Hall

inductance mésoscopique : cas de la barre de Hall

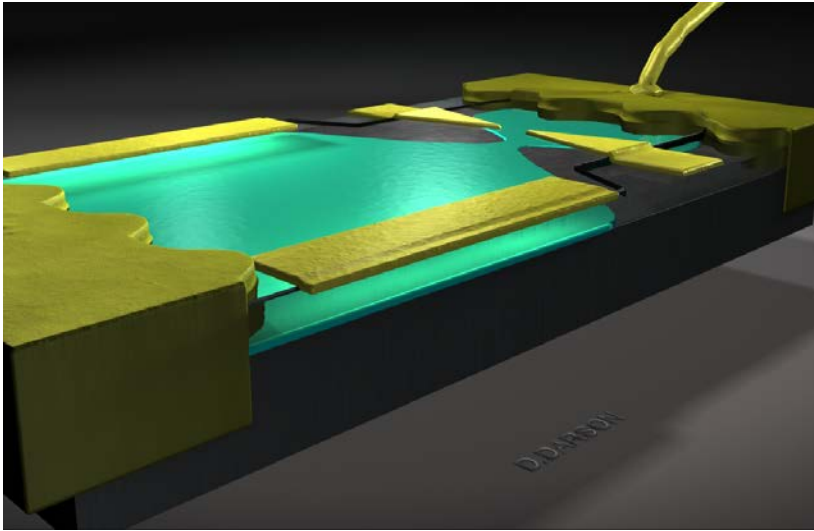

(c.f. : section C.2)

$$A = G + j\omega E = G(1 + j\omega\tau)$$

Thèse J. Gabelli,

Low frequency admittance of a quantized Hall conductor, T. Christen and M. Büttiker, PRB 53, 2064 (1996).

Low frequency admittance of a quantum point contact, T. Christen, M. Büttiker, PRL 77, 143 (1996)

Relaxation Time of a Chiral Quantum R-L Circuit, J. Gabelli, et al., PRL98, 166806 (2007)

Admittance des conducteurs de Hall quantiques

$$A_{\alpha,\beta}(\omega) = G_{\alpha,\beta} + i\omega E_{\alpha,\beta} + o(\omega^2)$$

$$E_{\alpha,\beta} = e^2 \sum_{k=+,-} \left[\frac{dN_{\alpha k \beta}}{d\varepsilon} - \frac{dN_{\alpha k}}{d\varepsilon} u_{k,\beta} \right] ;$$

$$\delta U_k = \sum_{\beta} u_{k,\beta} \delta V_{\beta} ; \quad \frac{dN_{\alpha k}}{d\varepsilon} = \sum_{\beta} \frac{dN_{\alpha k \beta}}{d\varepsilon}$$

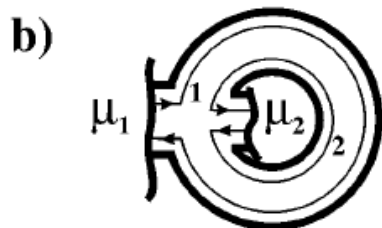
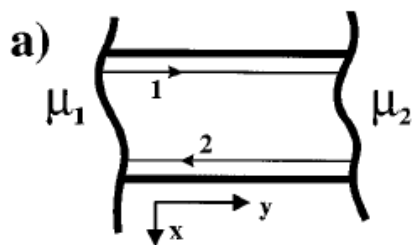
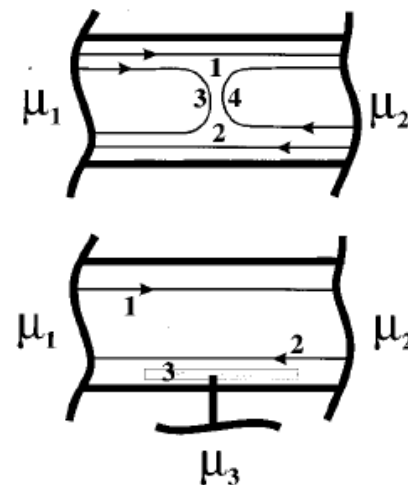

$$(a) \quad A_{1,2} = \frac{e^2}{h} - i\omega C_{\mu}$$

$$(C_{\mu}^{-1} = C_{geo}^{-1} + C_{Q+}^{-1} + C_{Q-}^{-1})$$

$$(b) \quad A_{1,2} = 0 + i\omega C_{\mu}$$

Low-frequency admittance of quantized Hall conductors, T. Christen, M. Büttiker, PRB53, 2064 (1996).

Barre de Hall + point quantiques (QHB+QPC)

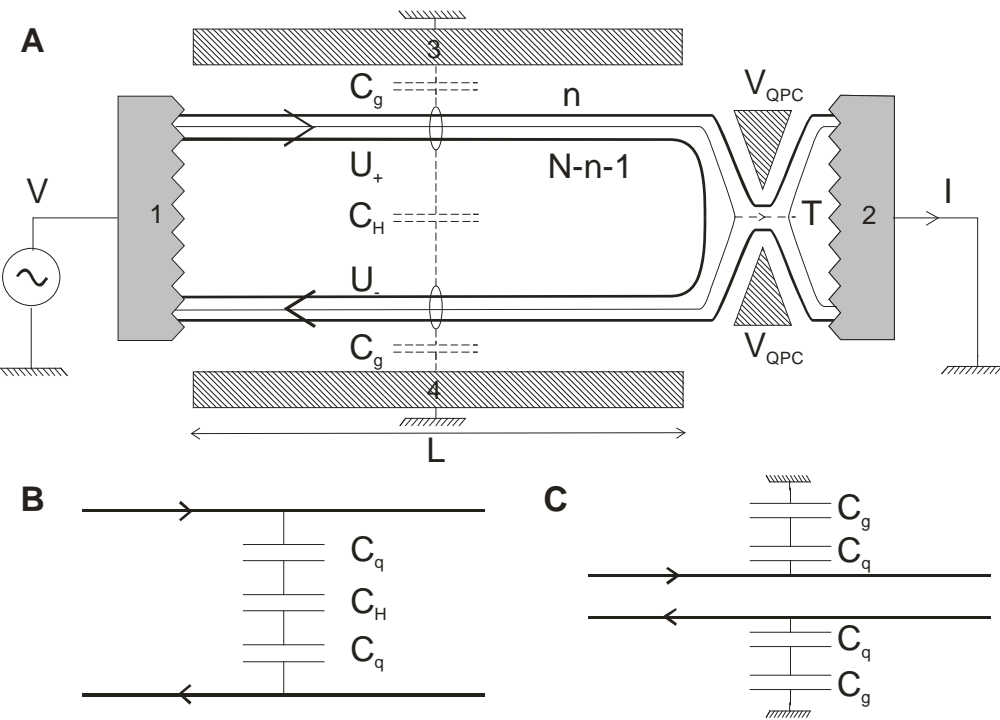

$$\frac{dN_{1,\pm,1}}{d\varepsilon} = [(1-T) + N - (n-1)] \frac{C_Q}{e^2}$$

$$\frac{dN_{2,+1}}{d\varepsilon} = \frac{dN_{1,-,2}}{d\varepsilon} = (T+n) \frac{C_Q}{e^2};$$

$$E_{21} = E_{12} = -C_{\mu g} \frac{(T+n)}{N} - \eta C_{\mu H} \frac{(T+n)^2}{N^2}$$

$$C_{\mu g} = \frac{NC_Q C_g}{C_g + NC_Q}; \quad C_{\mu H} = \frac{NC_Q C_H}{2C_H + NC_Q}$$

$$\eta = \frac{1}{1 + C_g / NC_Q} \quad \frac{1}{1 + C_g / (2C_H + NC_Q)}$$

Relaxation Time of a Chiral Quantum R-L Circuit, J. Gabelli, et MESO, PRL98, 166806 (2007)

Cas chiral ($C_H \ll C_g \leq C_Q$)

Relaxation Time of a Chiral Quantum R-L Circuit, J. Gabelli, et MESO, PRL98, 166806 (2007)

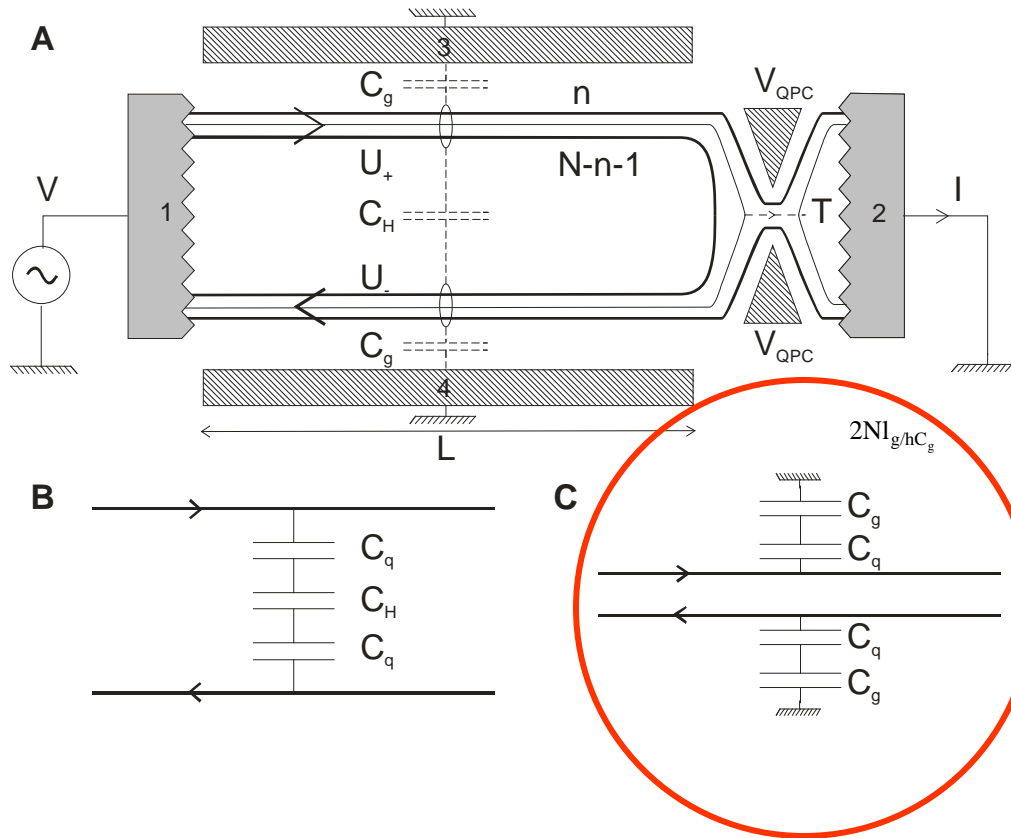

$$E \approx -C_{\mu g} \frac{(T+n)}{N} \propto G$$

$$A \approx G(1-i\omega\tau)$$

$$= (n+T) \frac{e^2}{h} \left(1 - i\omega \frac{h}{e^2} \frac{C_{\mu g}}{N} \right)$$

$$\tau = \frac{l_g}{v_D + 2Nl_g/hC_g} = Cte$$

Chiral : temps de relaxation indépendant de la résistance !!!

Cas non chiral ($C_g \ll C_g \leq C_H$) : fil quantique

Relaxation Time of a Chiral Quantum R-L Circuit, J. Gabelli, et MESO, PRL98, 166806 (2007)

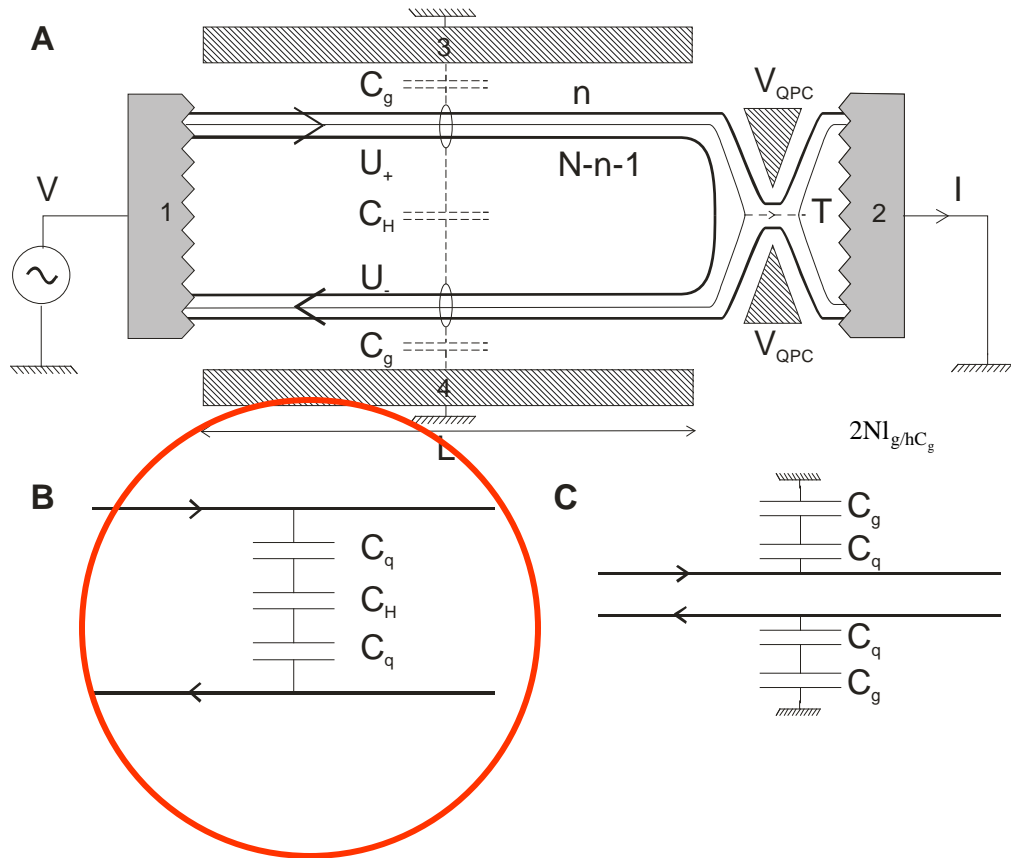

$$E \approx -C_{\mu H} \left(\frac{(T+n)}{N} \right)^2$$

$$G = (n+T) \frac{e^2}{h}$$

$$A \approx G(1-i\omega\tau)$$

$$\tau = G \frac{h^2}{e^4} C_{\mu H} = GL_{\mu}$$

$$L_{\mu} = \frac{h^2}{e^4} \frac{C_{\mu H}}{N^2}$$

Classique : Inductance électrochimique série avec la résistance

Admittance au premier ordre en fréquence

- The sample:

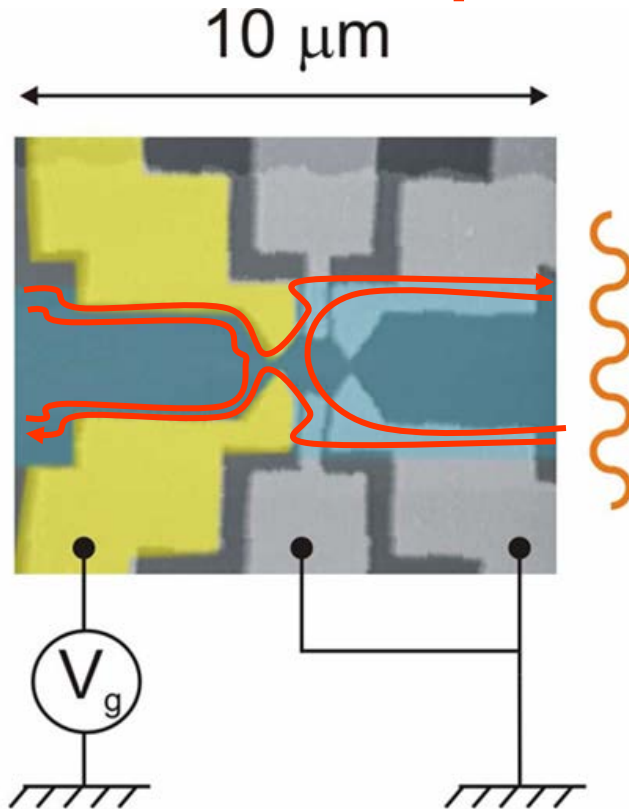
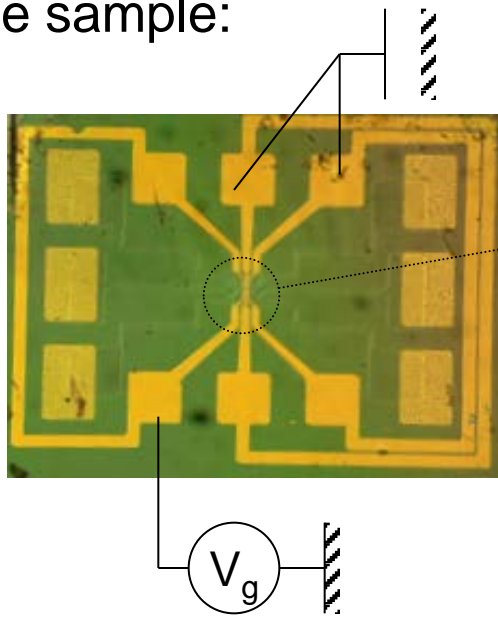

- The r.f. circuit:

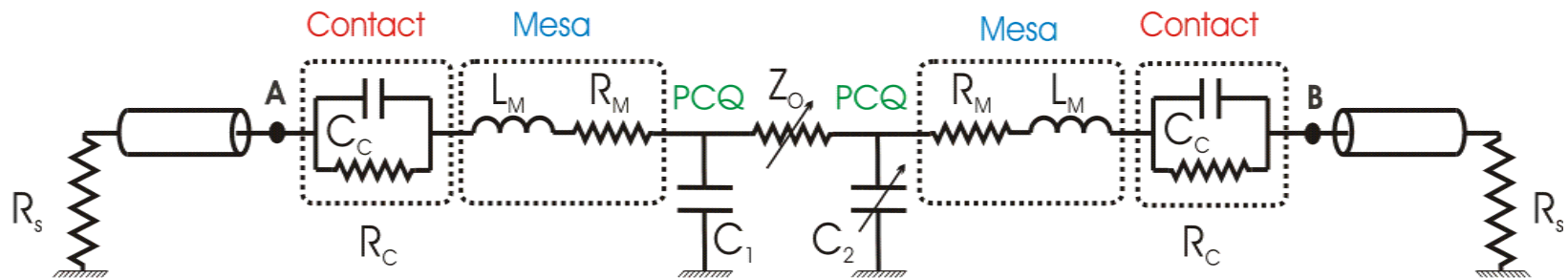

Conductance haute fréquence du point quantique

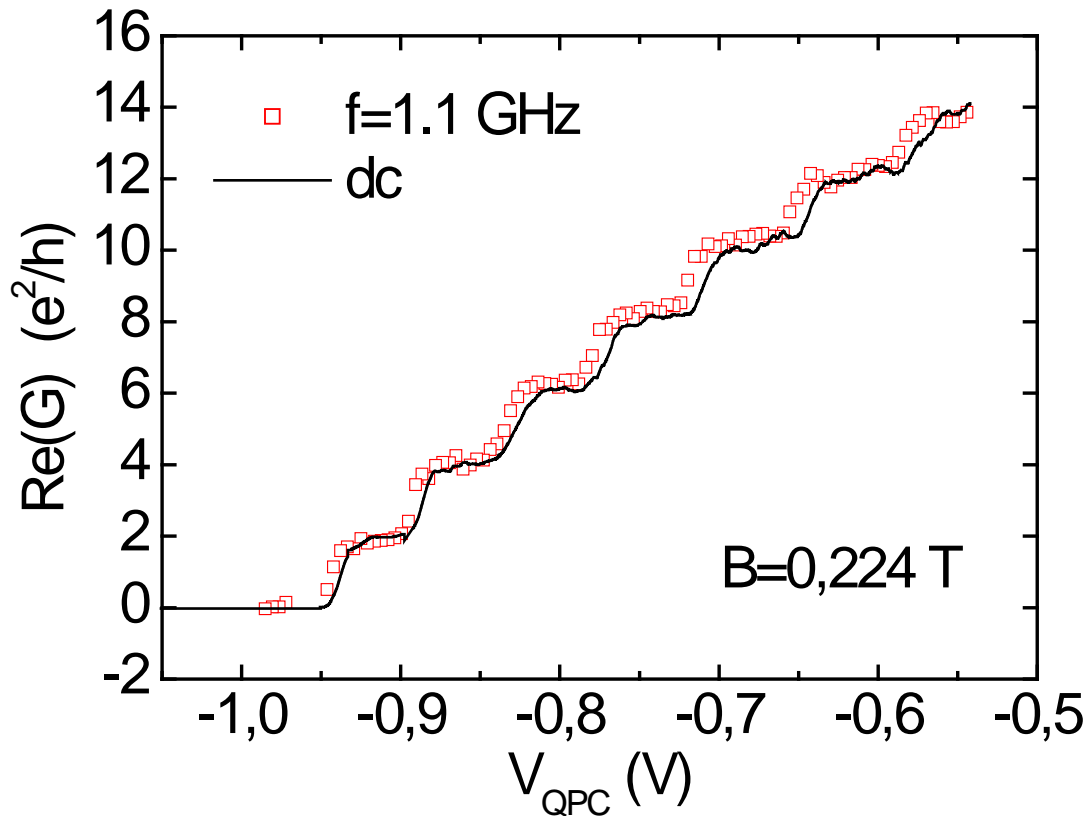

$$\text{Re}(A) = G(\omega) \approx G(0)$$



Régime basse fréquence : transmission indépendante de f

Partie imaginaire de l'admittance : l'émittance d'une barre de Hall

$$A = G + j\omega E = G(1 + j\omega\tau)$$

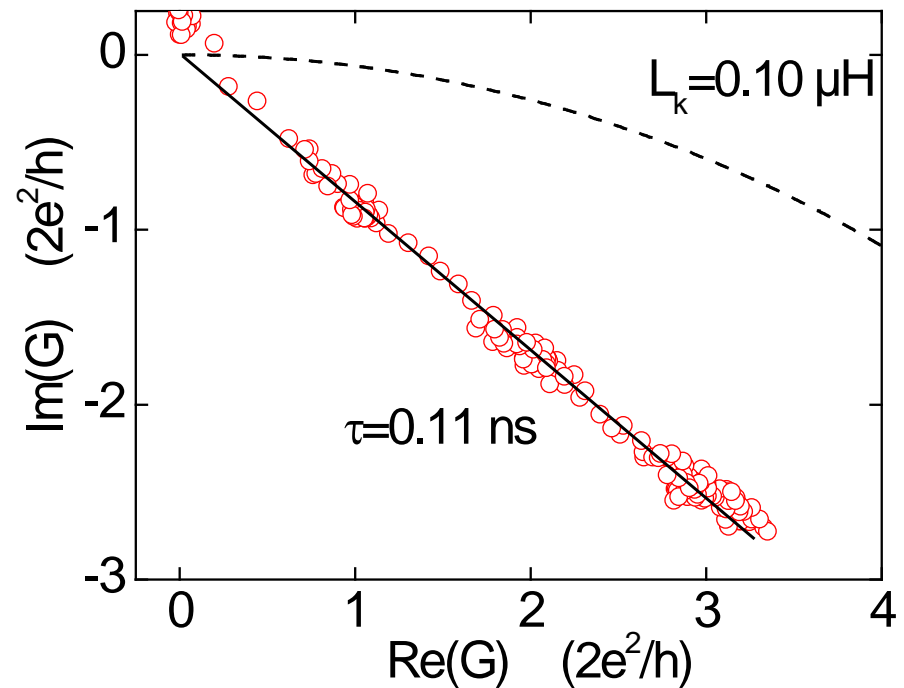
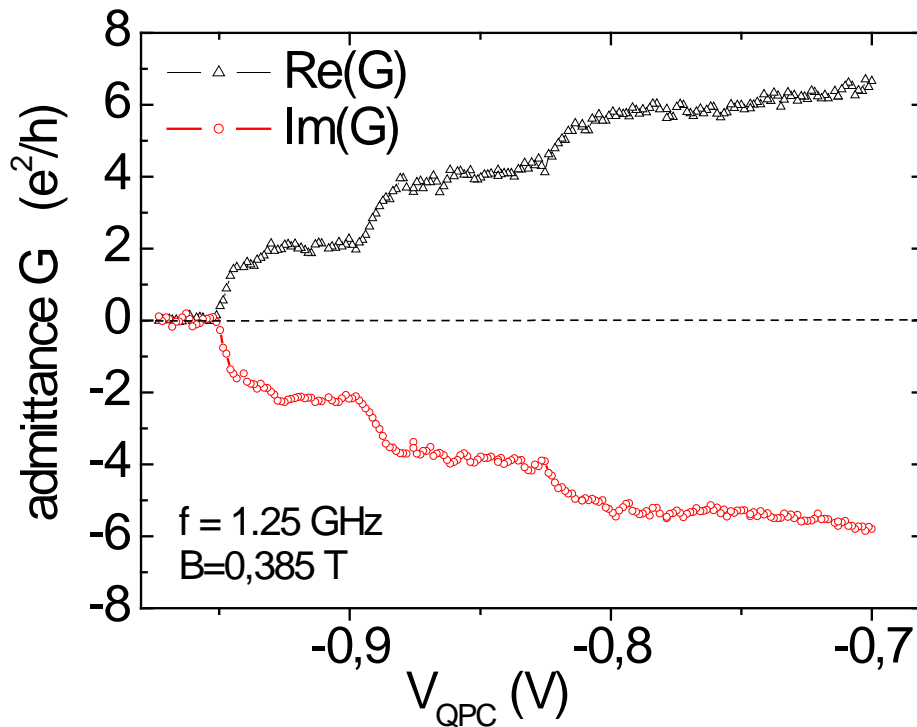

Une mesure indirecte de la vitesse de dérivation

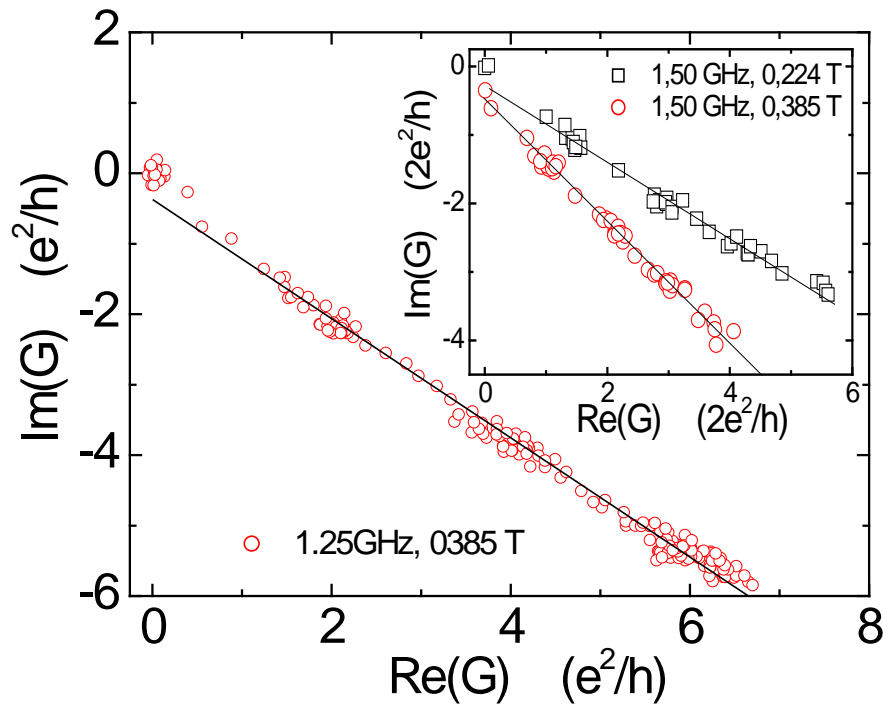

$$\tau = \frac{L_g}{v_D} \propto B$$
$$v_D = \frac{E_{\text{bord}}}{B} = \frac{n_s e}{\epsilon B} \approx 10^5 \text{ m/s}$$

L'admittance mesure des temps monoélectroniques !!!

capacité d'un contact ponctuel ?

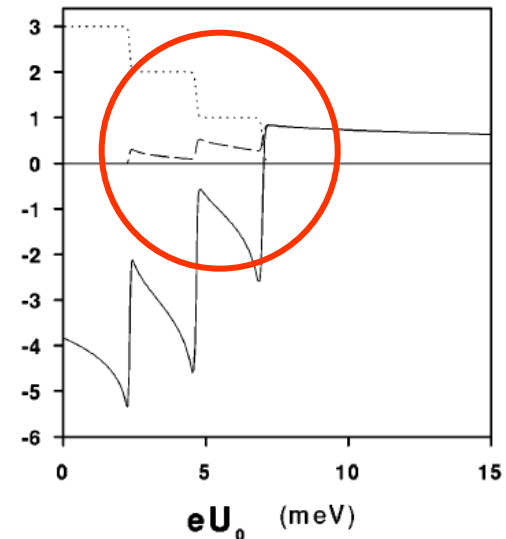
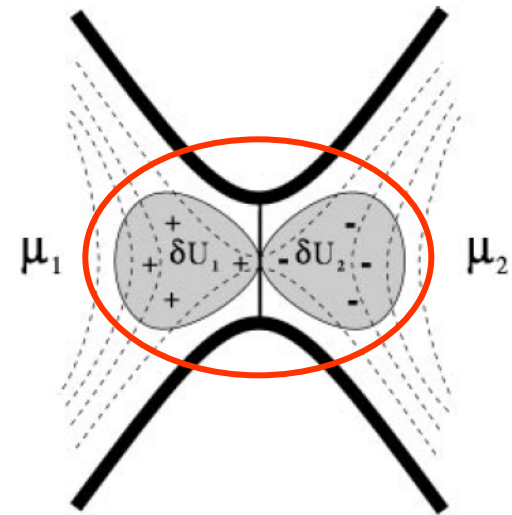
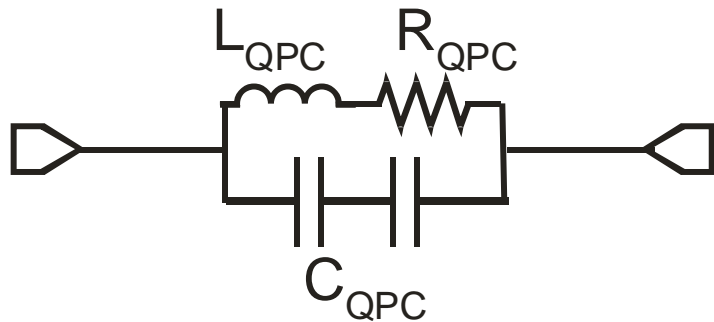
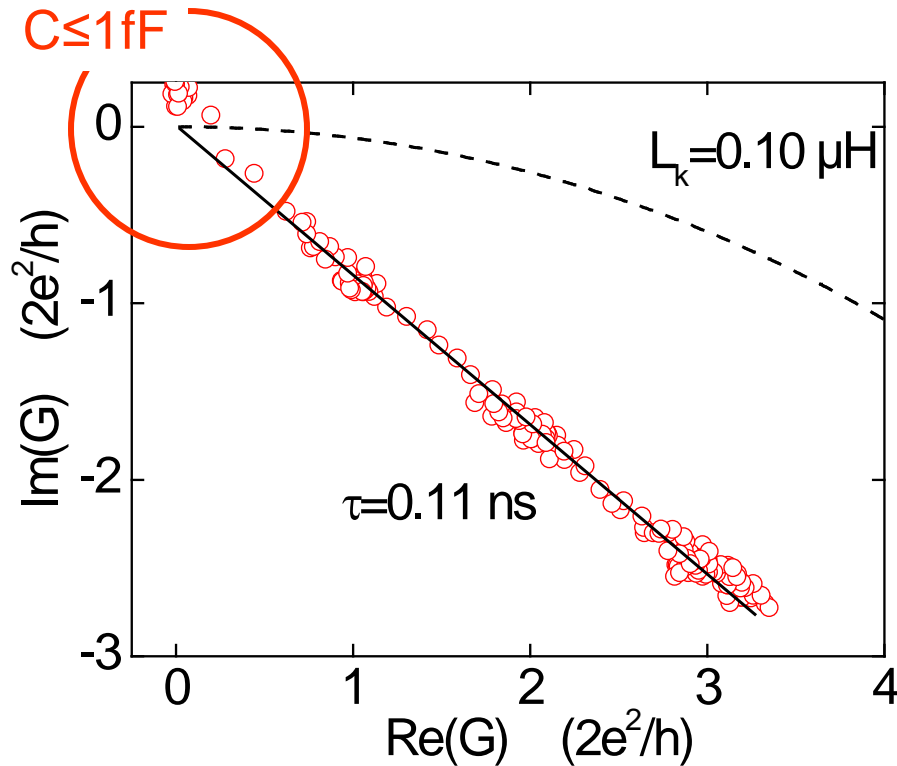
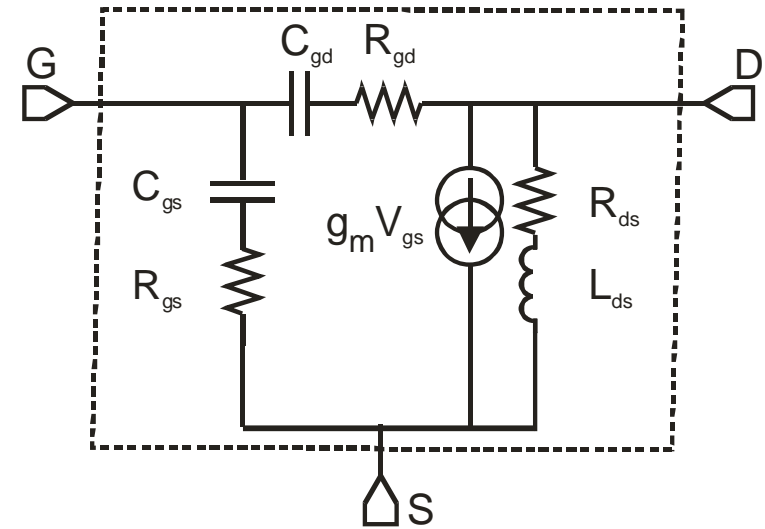
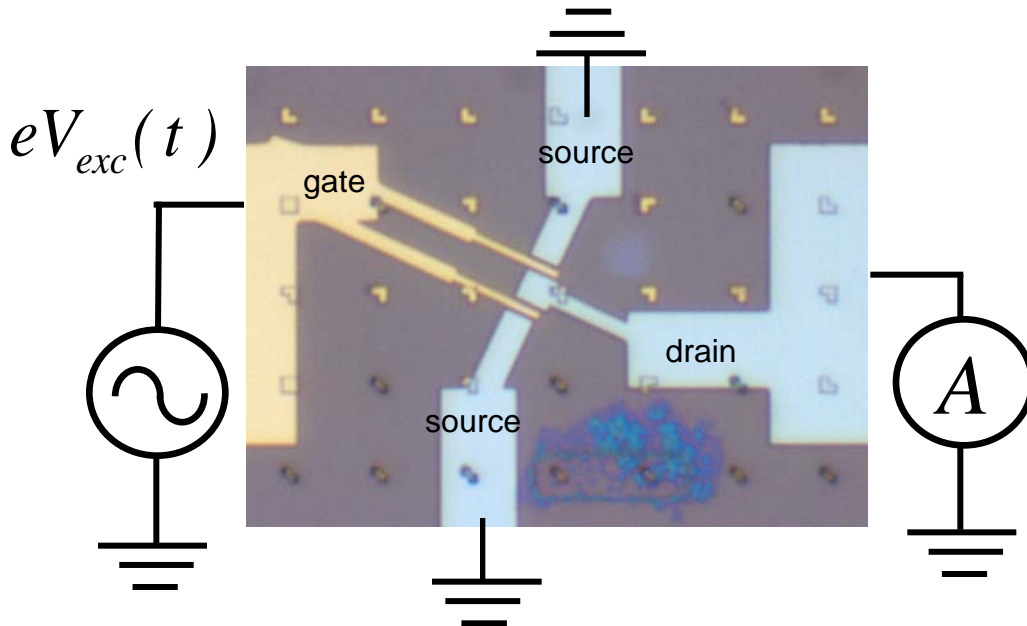
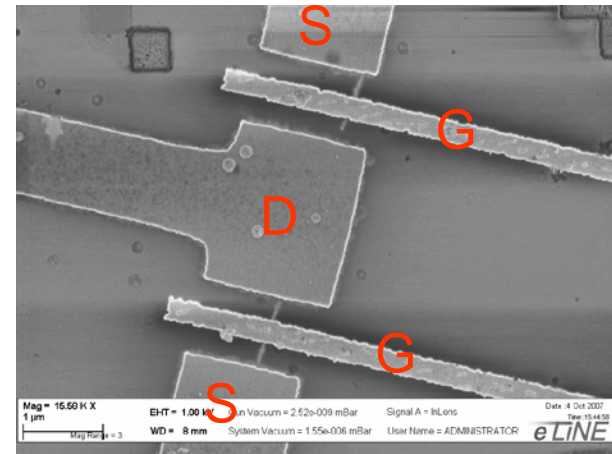
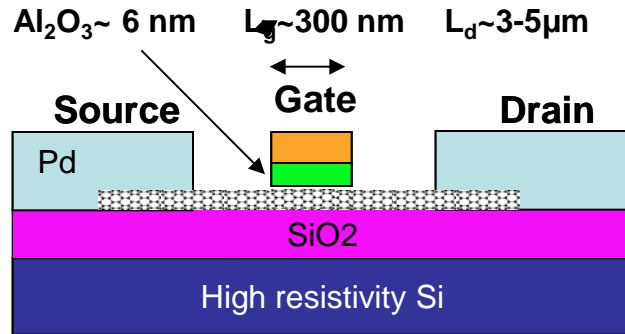

FIG. 2. Dependence of the conductance (in units $2e^2/h$; dotted curve), capacitance, and emittance (in units of fF; dashed and full curves, respectively) on the barrier height eU_0 for a quantum point contact with three relevant channels (see Fig. 1).

Fréquence de transit d'un nano-transistor mésoscopique

transistor mésoscopique à nanotube unique



Caractéristiques dc des transistors

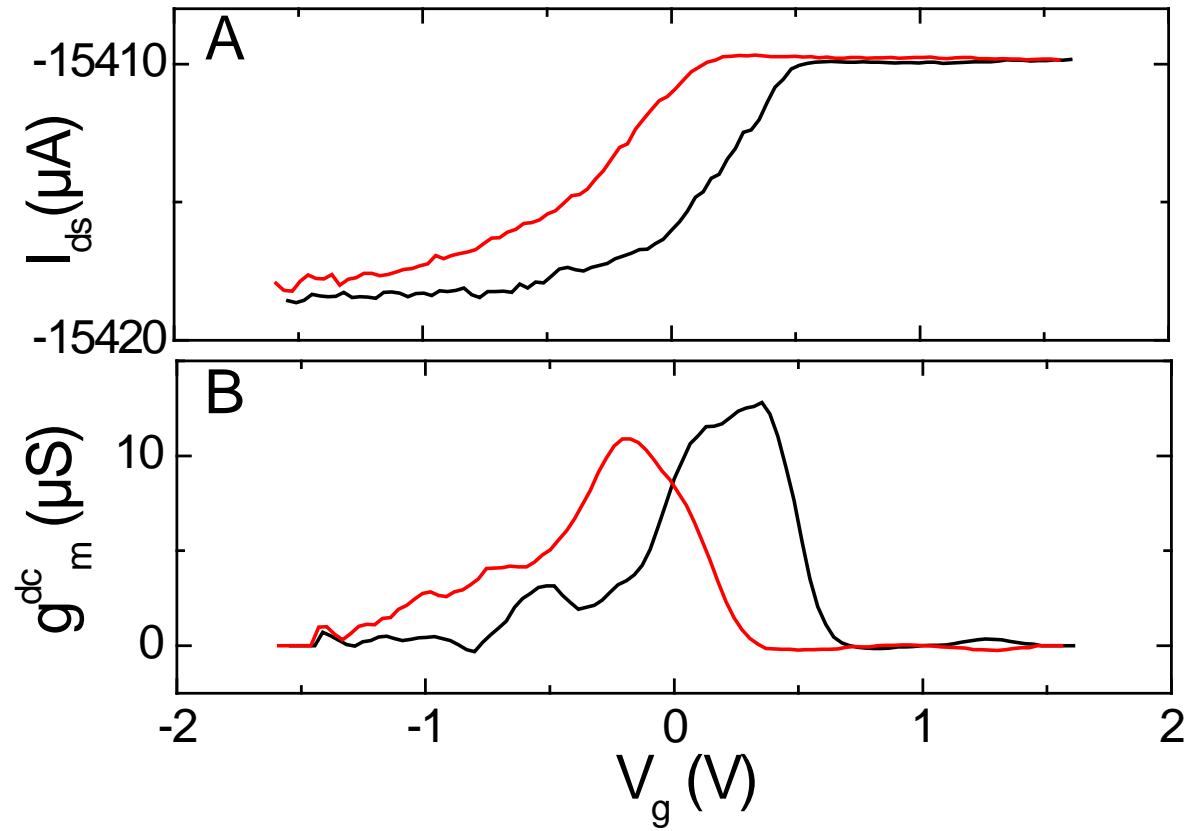

Dynamique du nanotransistor (basse énergie)

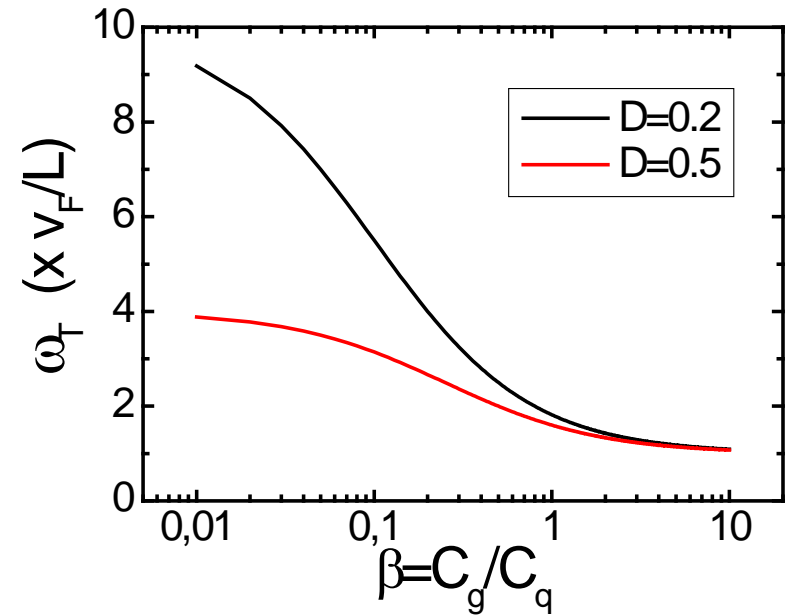
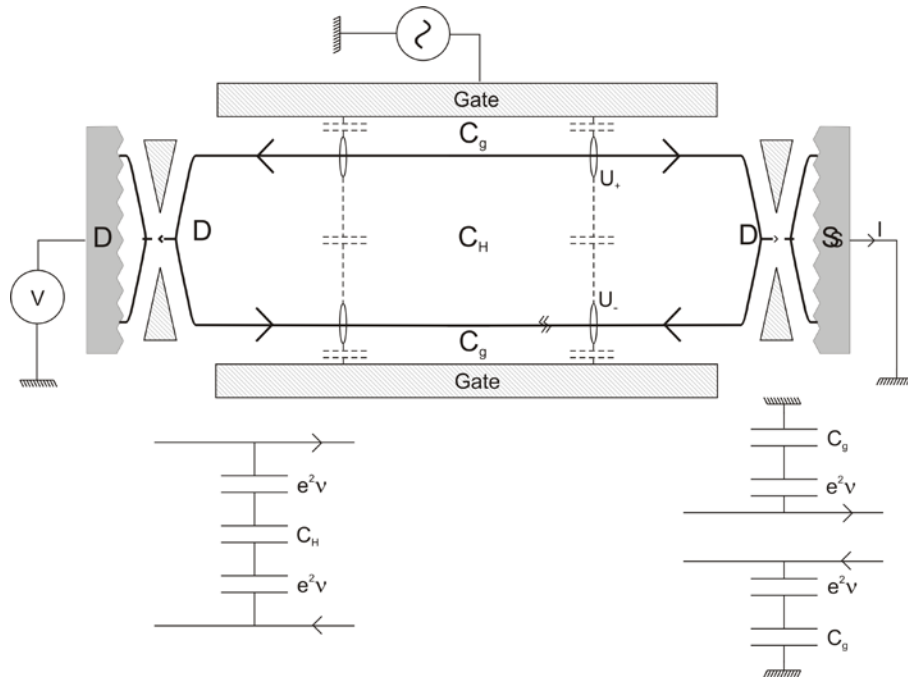

$$E = -C_{\mu g} \frac{(T+n)}{N} - \eta C_{\mu H} \frac{(T+n)^2}{N^2} ; \quad C_{\mu g} = \frac{NC_Q C_g}{C_g + NC_Q} ; \quad C_{\mu H} = \frac{NC_Q C_H}{2C_H + NC_Q} ; \quad \eta = \dots$$

$$(N=4, n=3T \text{ et } C_H \rightarrow \infty) ; \quad \tau = \omega_T^{-1} = \frac{E}{G} \approx \frac{L}{v_F} \times \left[\frac{D/2 + \beta}{1 + \beta} \right]$$

Mesure d'admittance grille-drain et capacité de grille

J. Chaste et al MESO, Nanoletters 8 525 (2008)

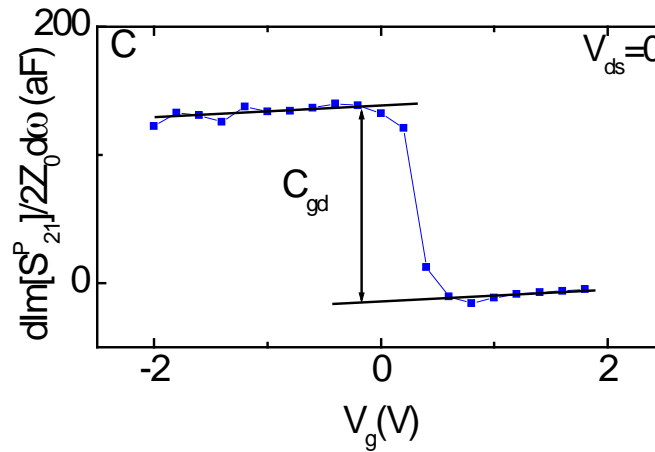
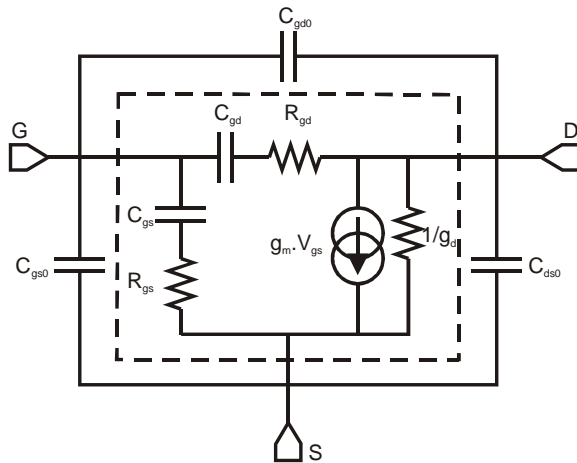
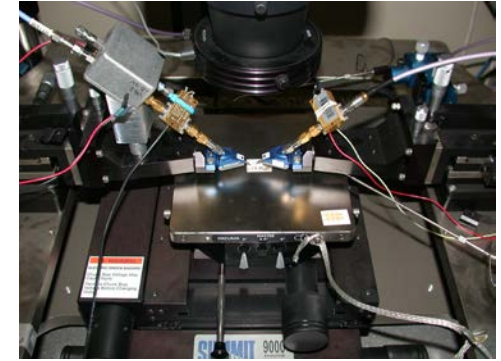
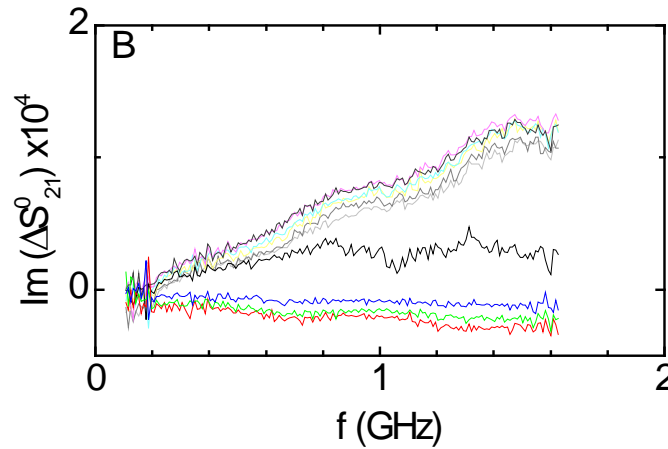
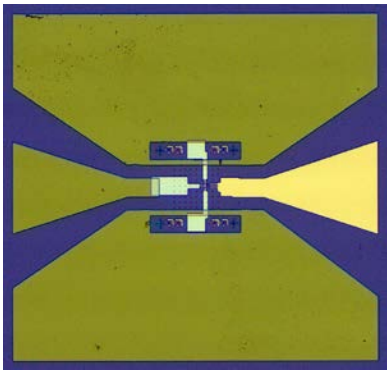

Gate length = 3 μm

$$S_{21} \approx \frac{2Z_0 j\omega C_{gd}}{1 + j\omega R_{gd} C_{gd}}$$

Estimation de la fréquence de transit

J. Chaste et al MESO, Nanoletters 8 525 (2008)

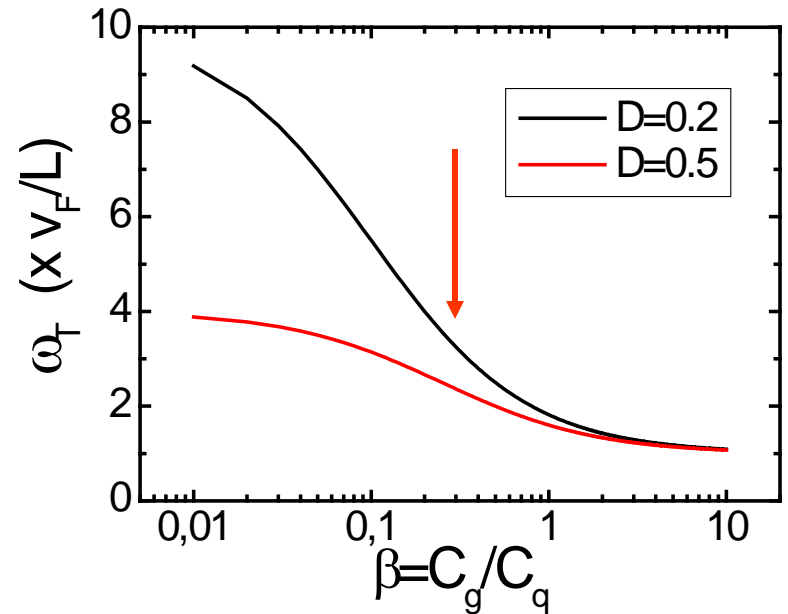
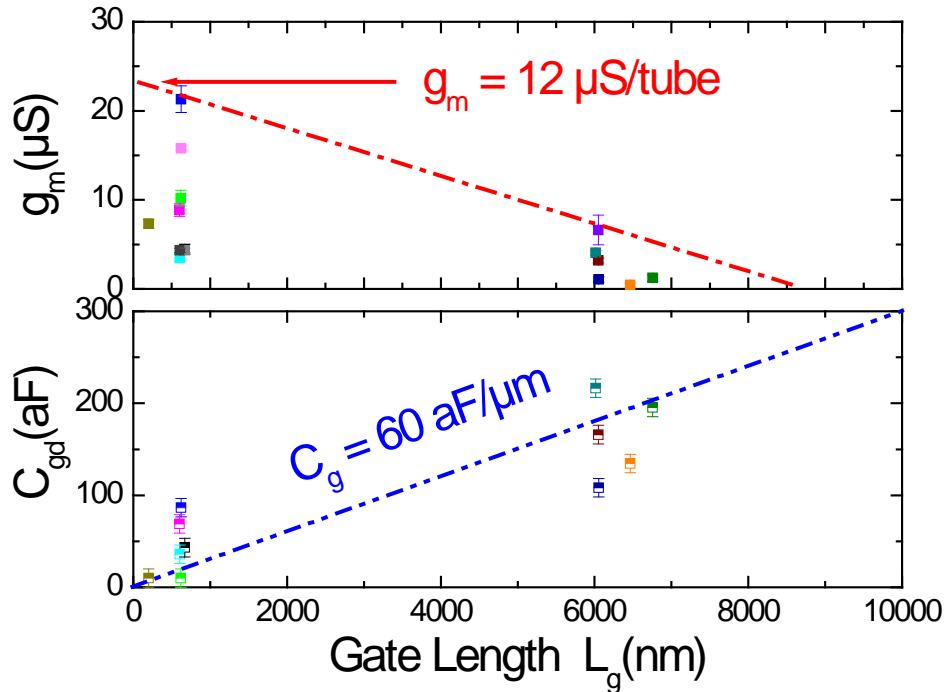

$$\beta = \frac{C_g}{C_Q} \approx \frac{60}{200} = 0.3 \quad ; \quad D \approx 0.1$$

$$\omega_T = \frac{g_m}{2C_{gd}} \approx 2\pi \times 50 \text{ GHz} \quad ; \quad \frac{v_D}{L_g} \approx \frac{qqs10^5}{3 \times 10^{-7}} = qqs \times 2\pi \times 50 \text{ GHz}$$

Plan du cours

A. Introduction à la dynamique mésoscopique

1. Introduction
2. Apport des hautes fréquences
3. Mesurables

B. Techniques expérimentales

1. Paramètres de diffusion
2. Montages de mesure de signaux rf faibles

C. Admittance de conducteurs quantiques

1. Relaxation de charge d'une capacité mésoscopiques
2. Inductance mésoscopique d'une barre de Hall
3. Dynamique de transistors à nanotube de carbone

D. Manipuler des électrons uniques

1. Injection d'électrons uniques
2. Vers la détection d'électrons volants

Motivation : electronic analogs of quantum optics

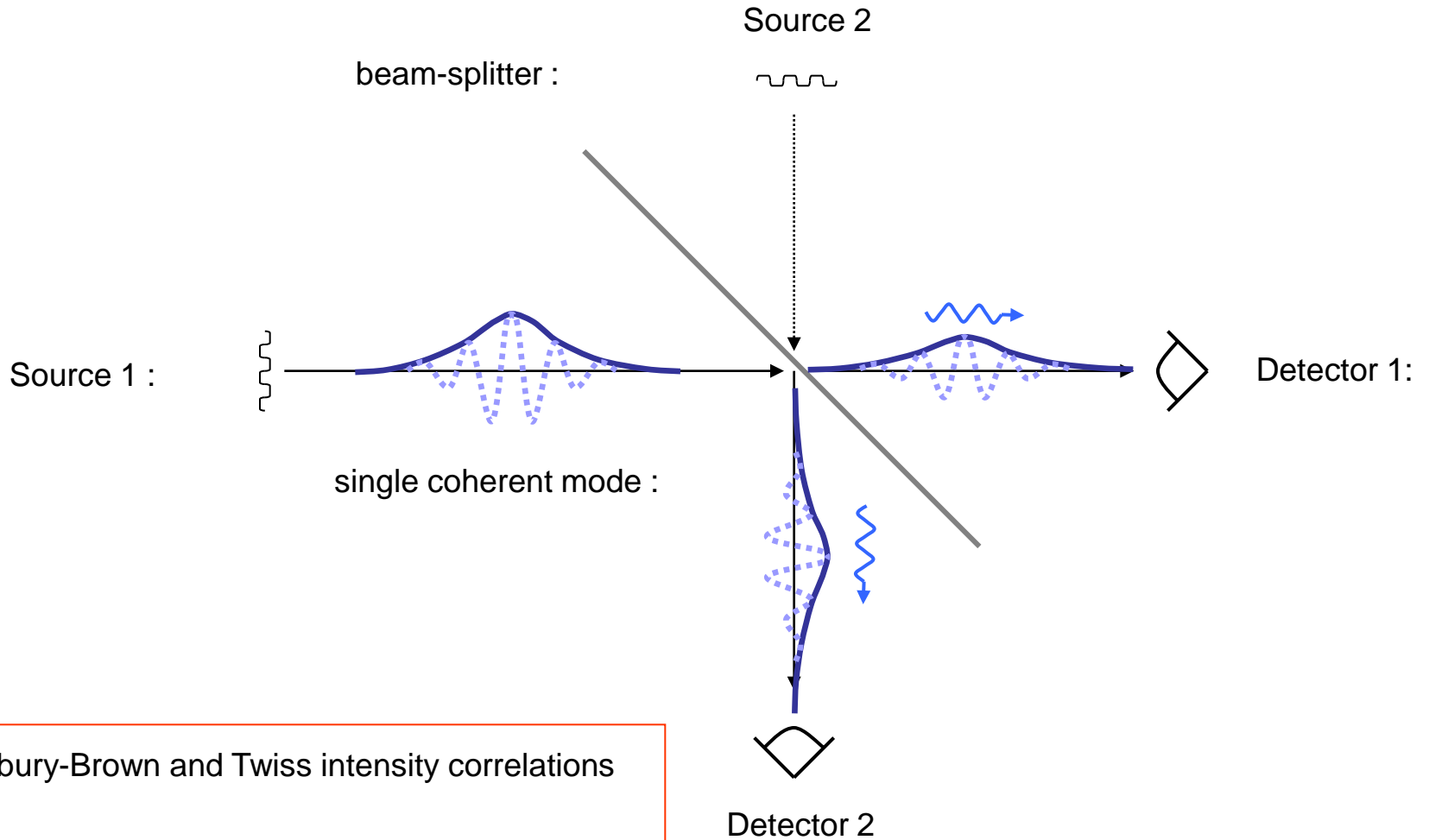

Electronic analog of quantum optics : QHE in 2DEGs

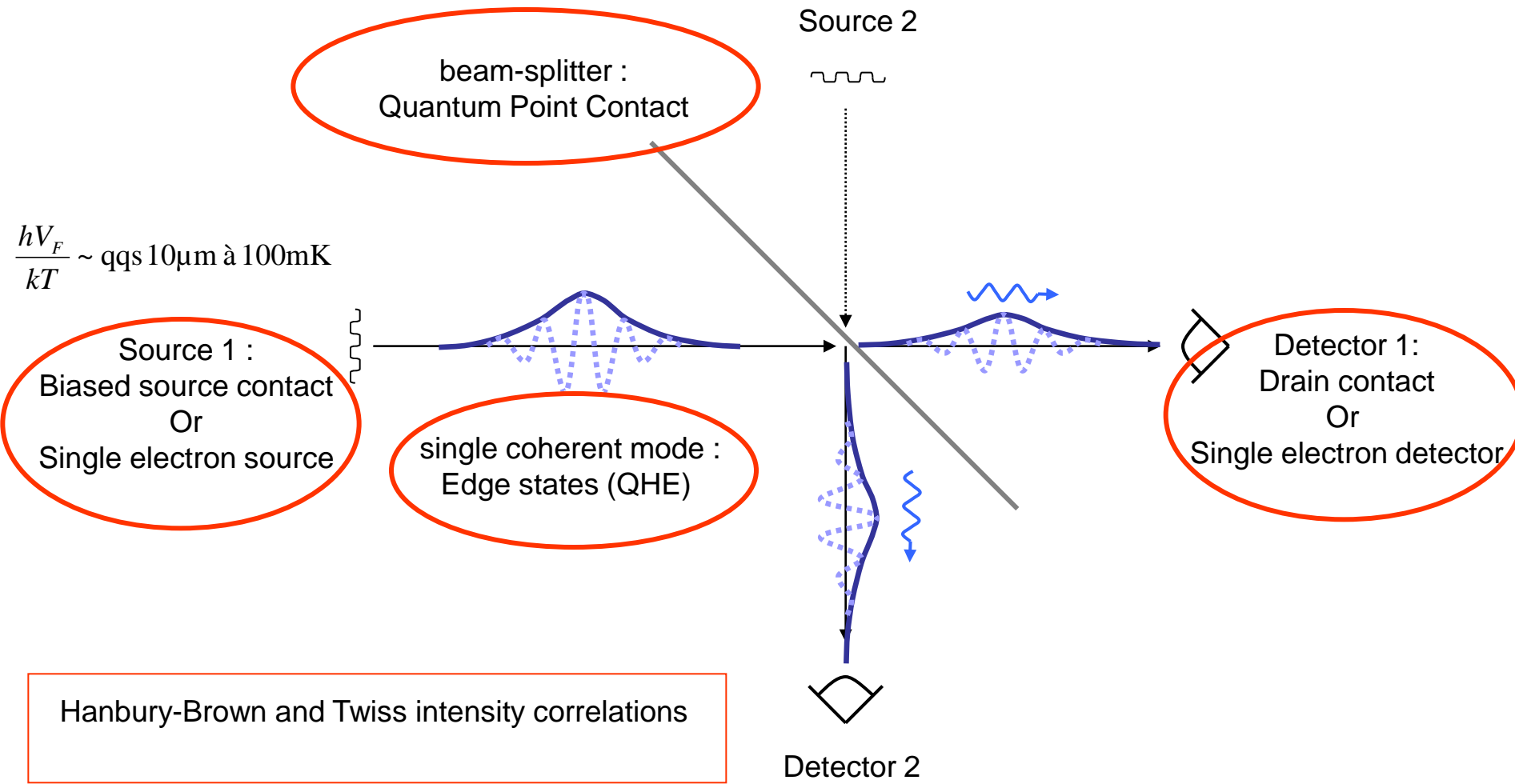

Collisions à deux électrons

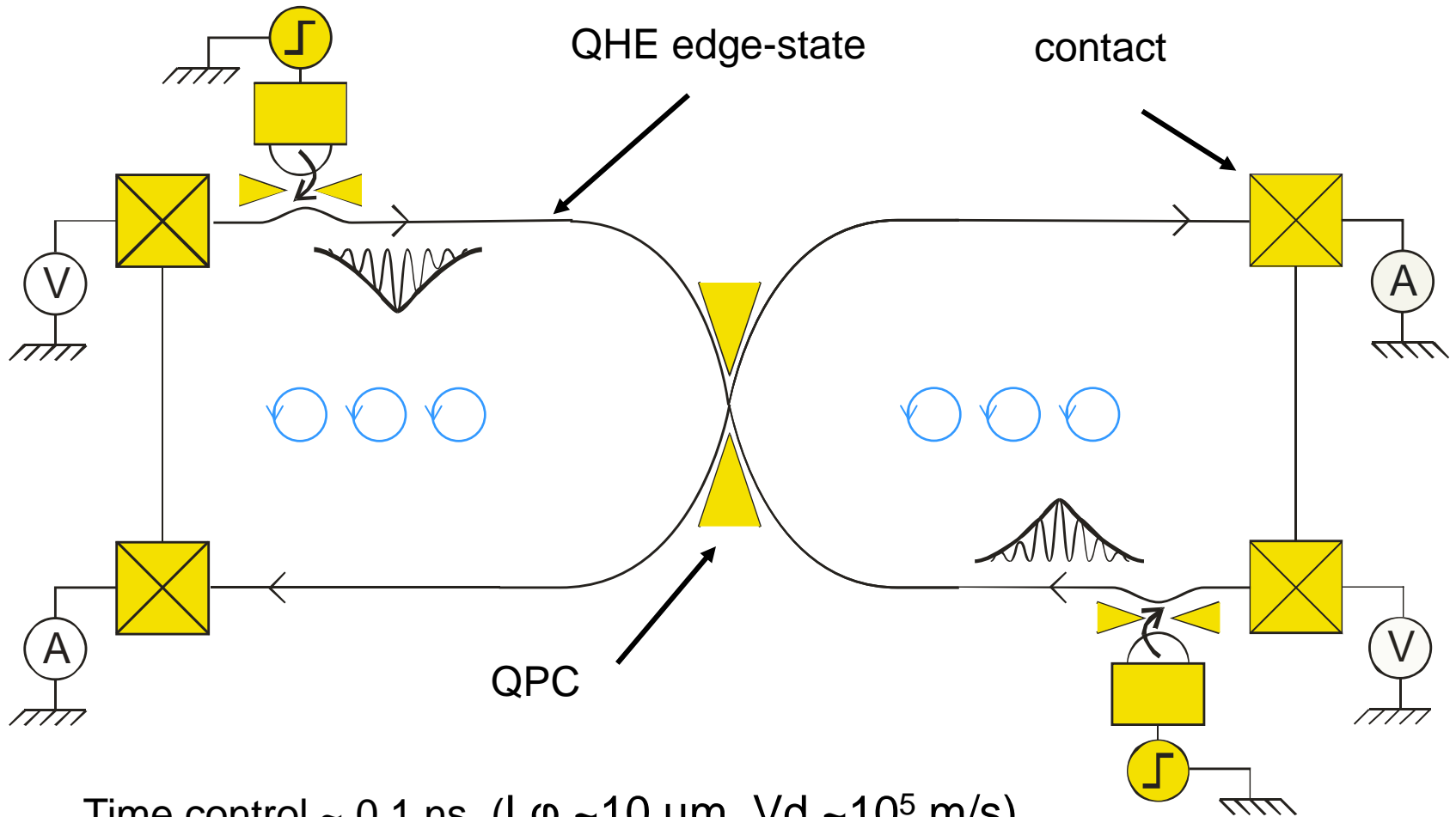

Energy control

La lame séparatrice (beam splitter)

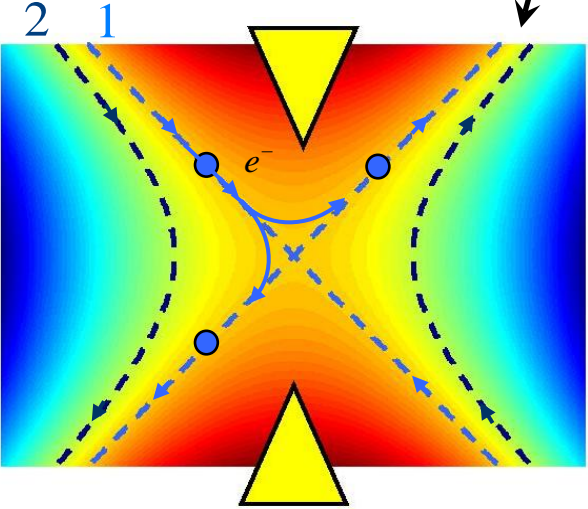
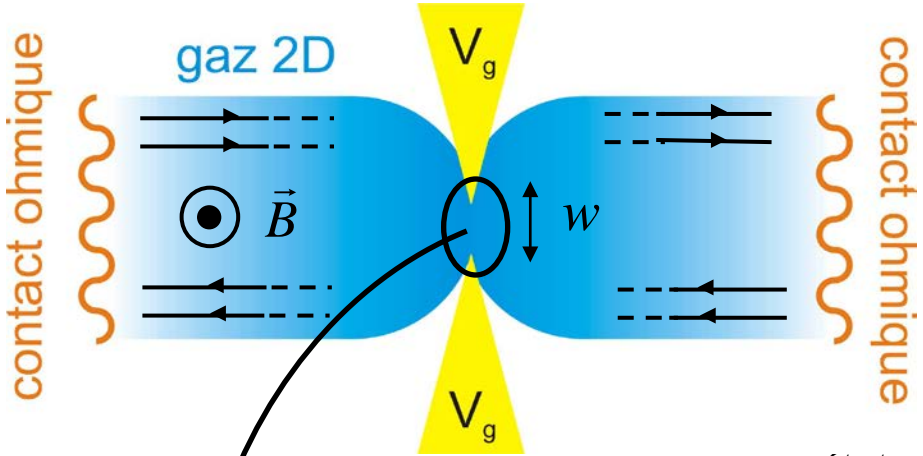

états de bord = équipotentielles

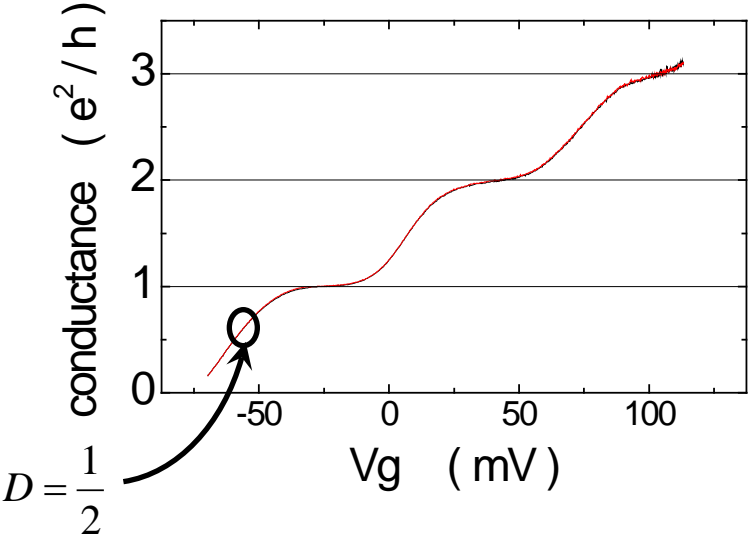

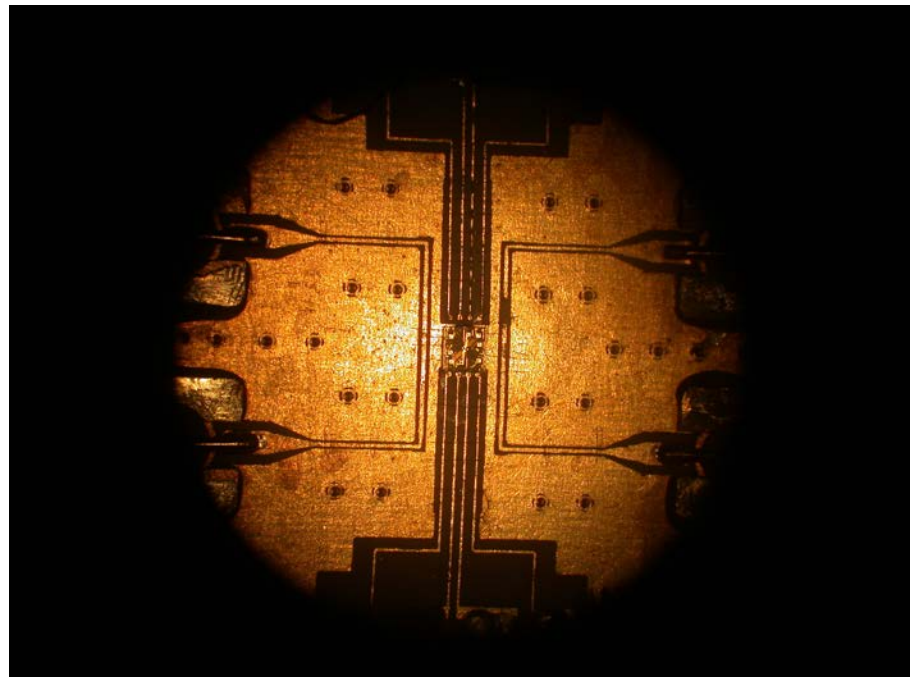
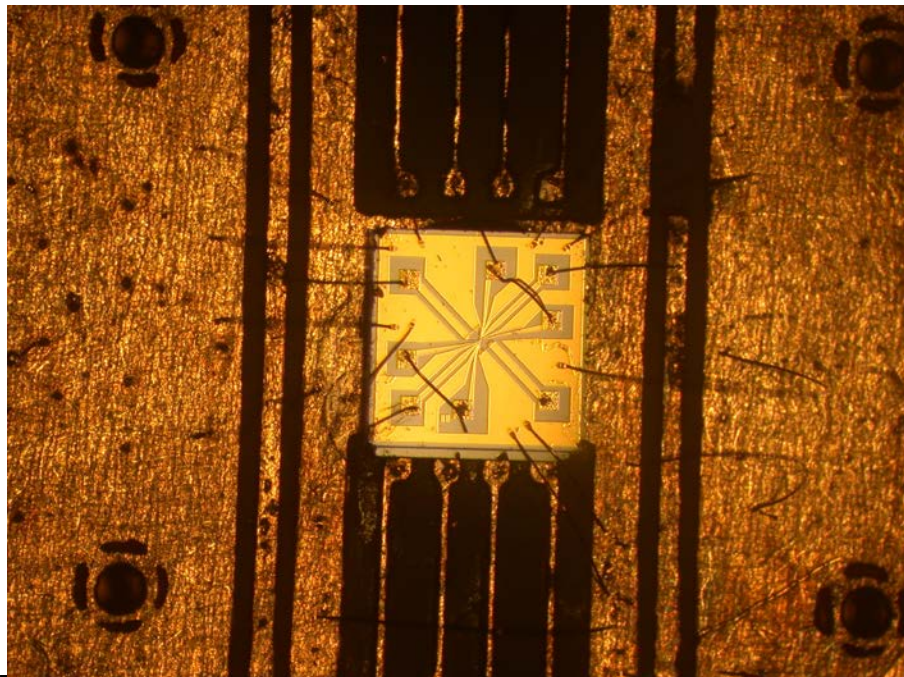
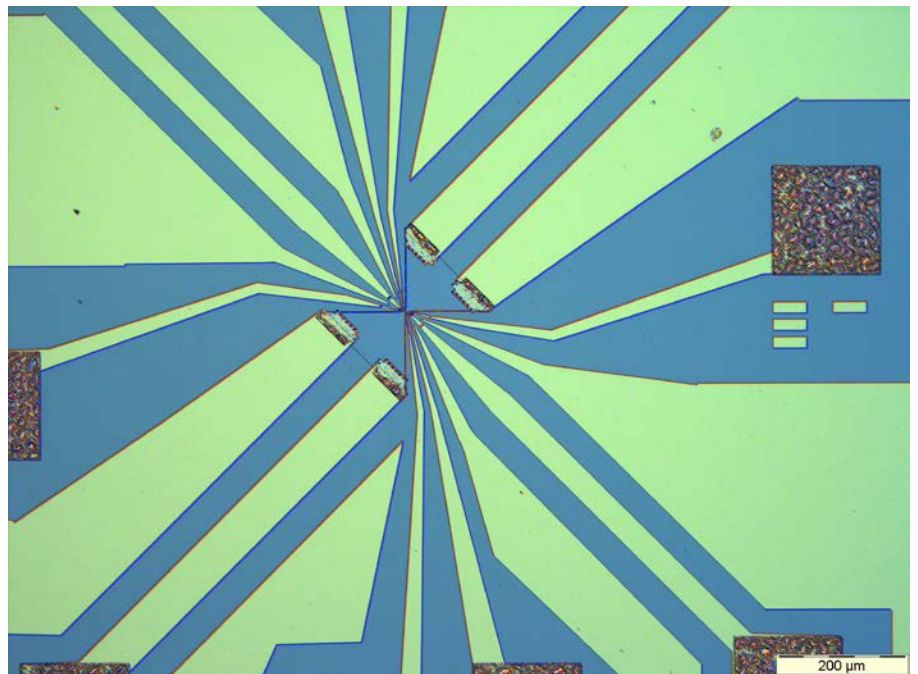
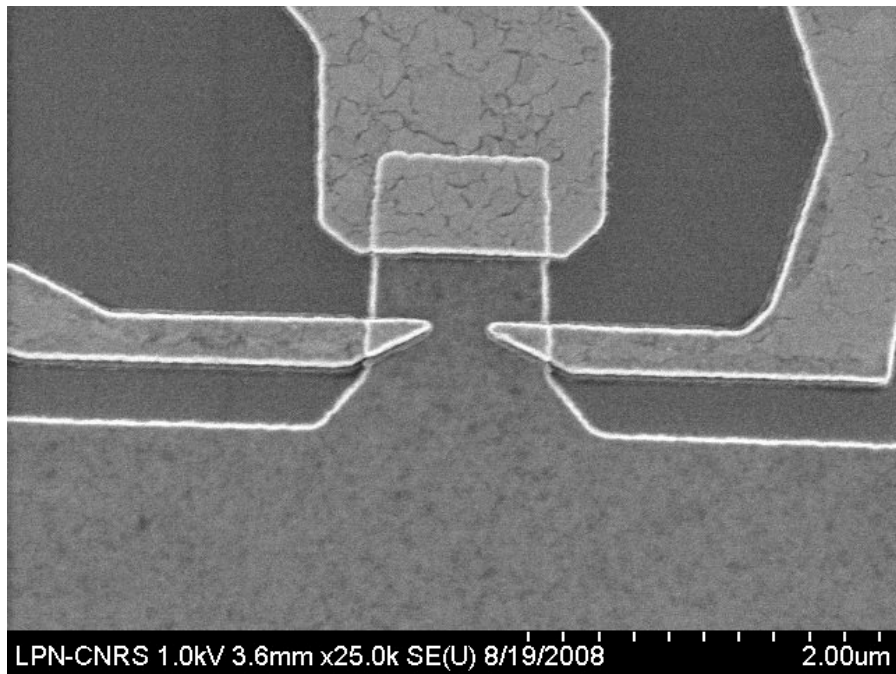

Injection d'électrons uniques

the single electron source

G. Fève thesis, <http://tel.archives-ouvertes.fr/tel-00119589/fr>

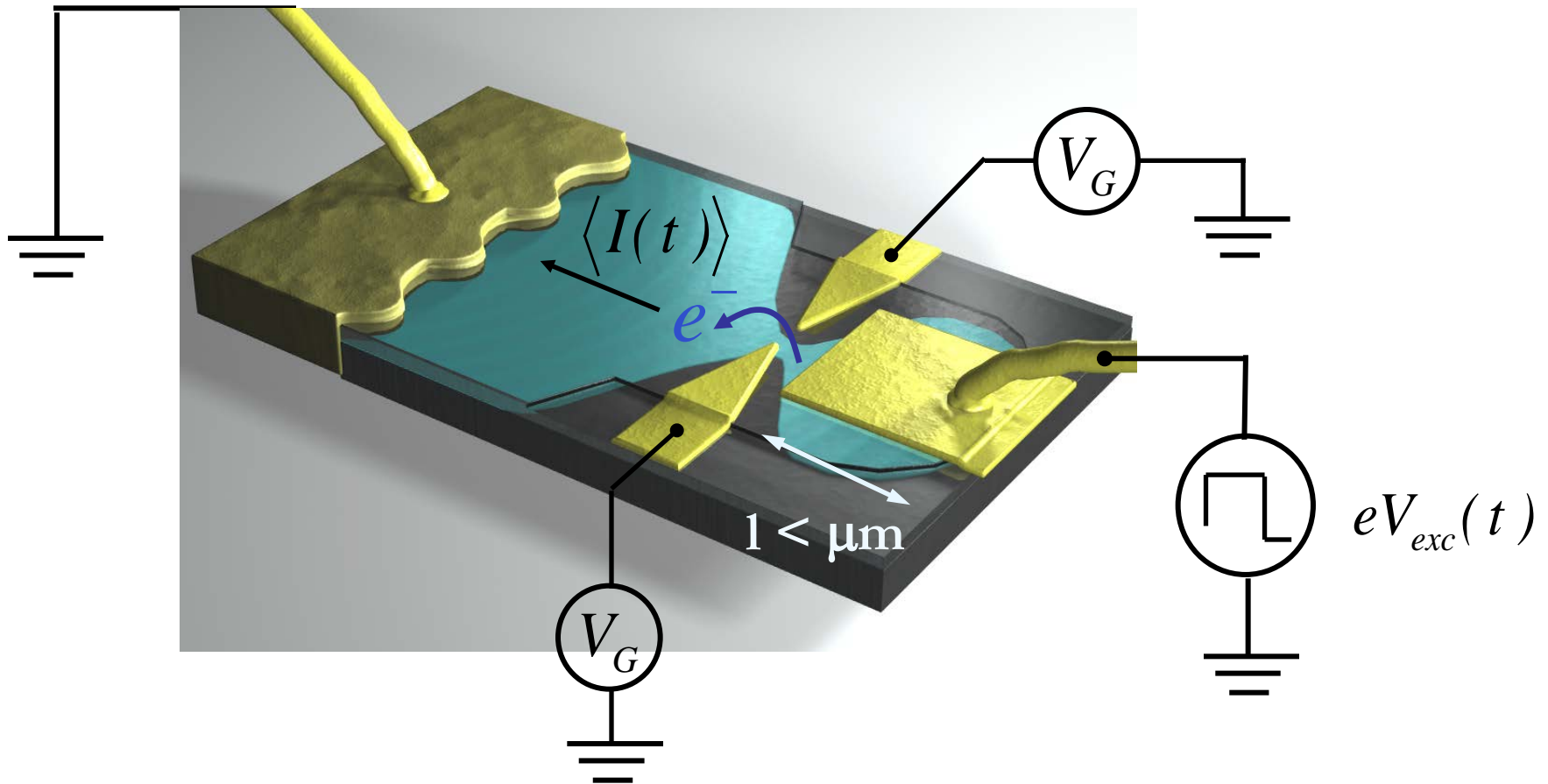

Principle of single electron injection

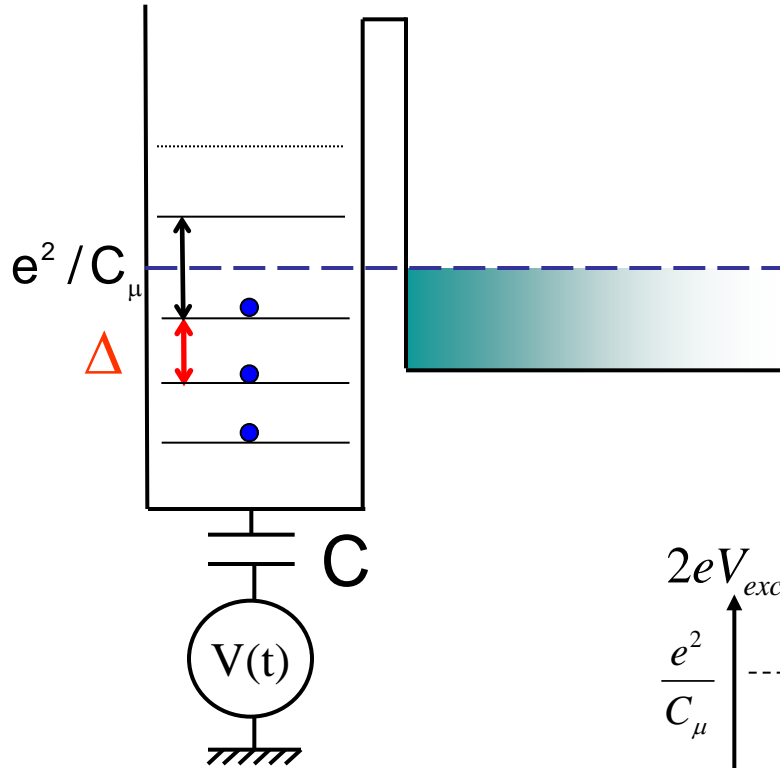

$$\frac{e^2}{C_\mu} = \frac{e^2}{C} + \Delta \quad (\approx 2.5\text{K})$$

transmission $D = 0.001 - 1$
 $\Gamma \approx 2\text{mK} - 2\text{K}$

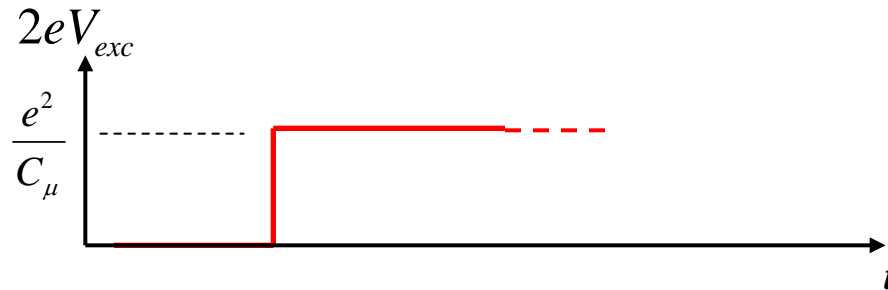
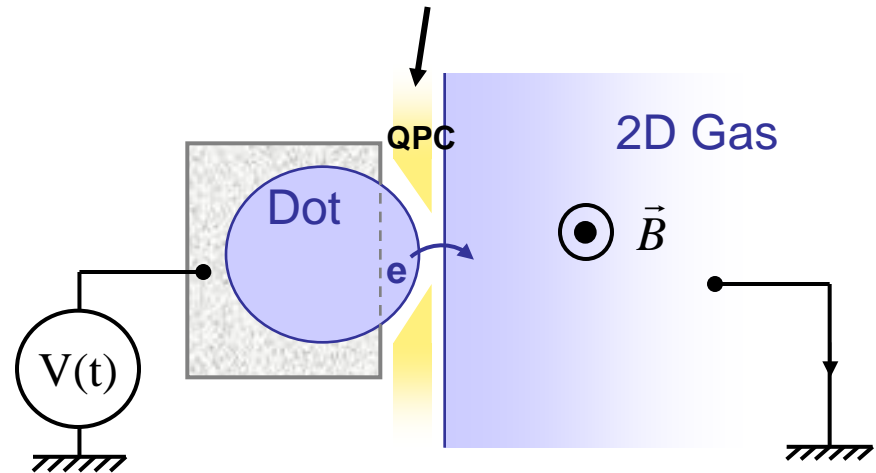

Principle of single electron injection

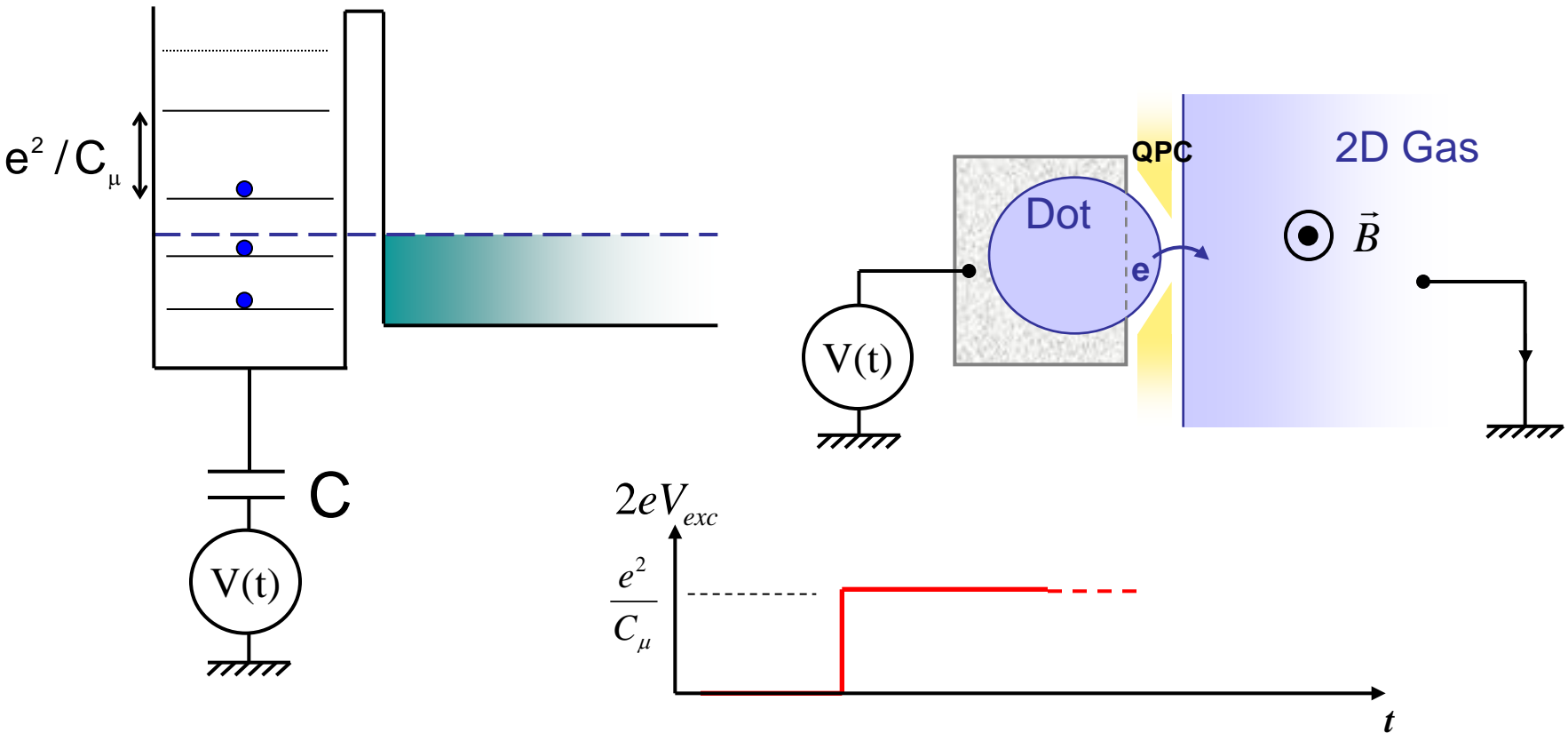

Principle of single electron injection

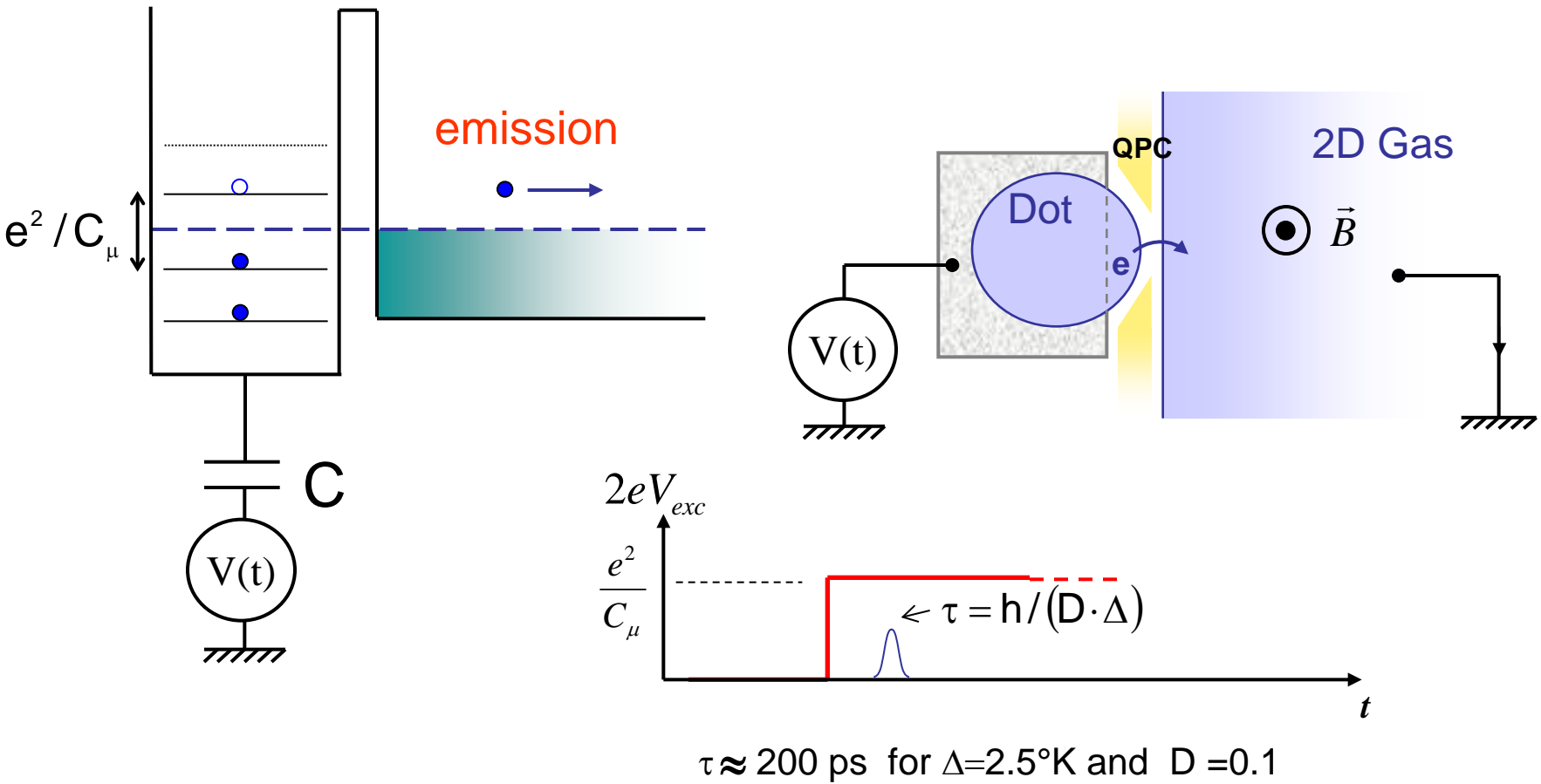

Principle of single electron injection

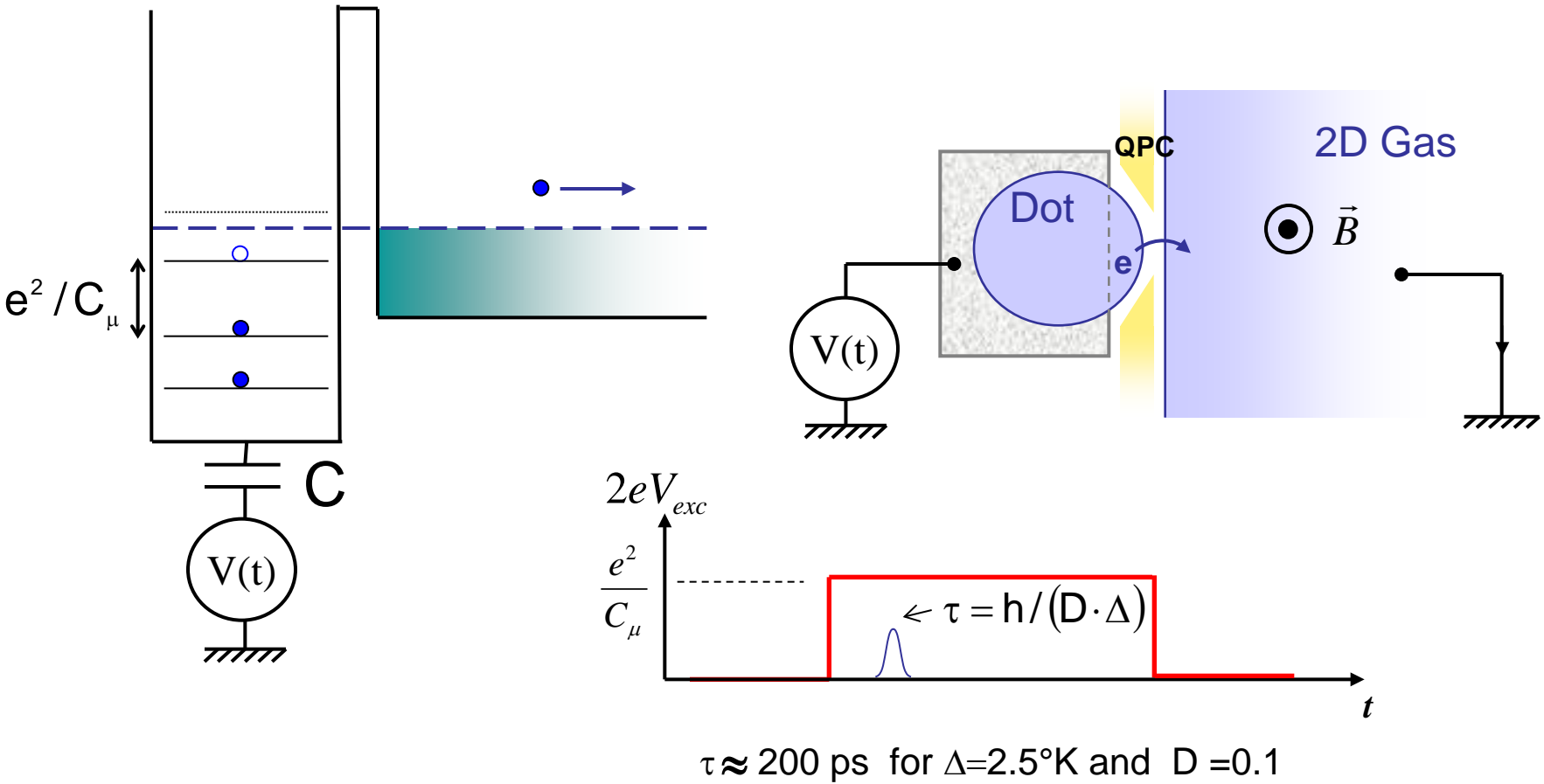

Principle of single electron injection

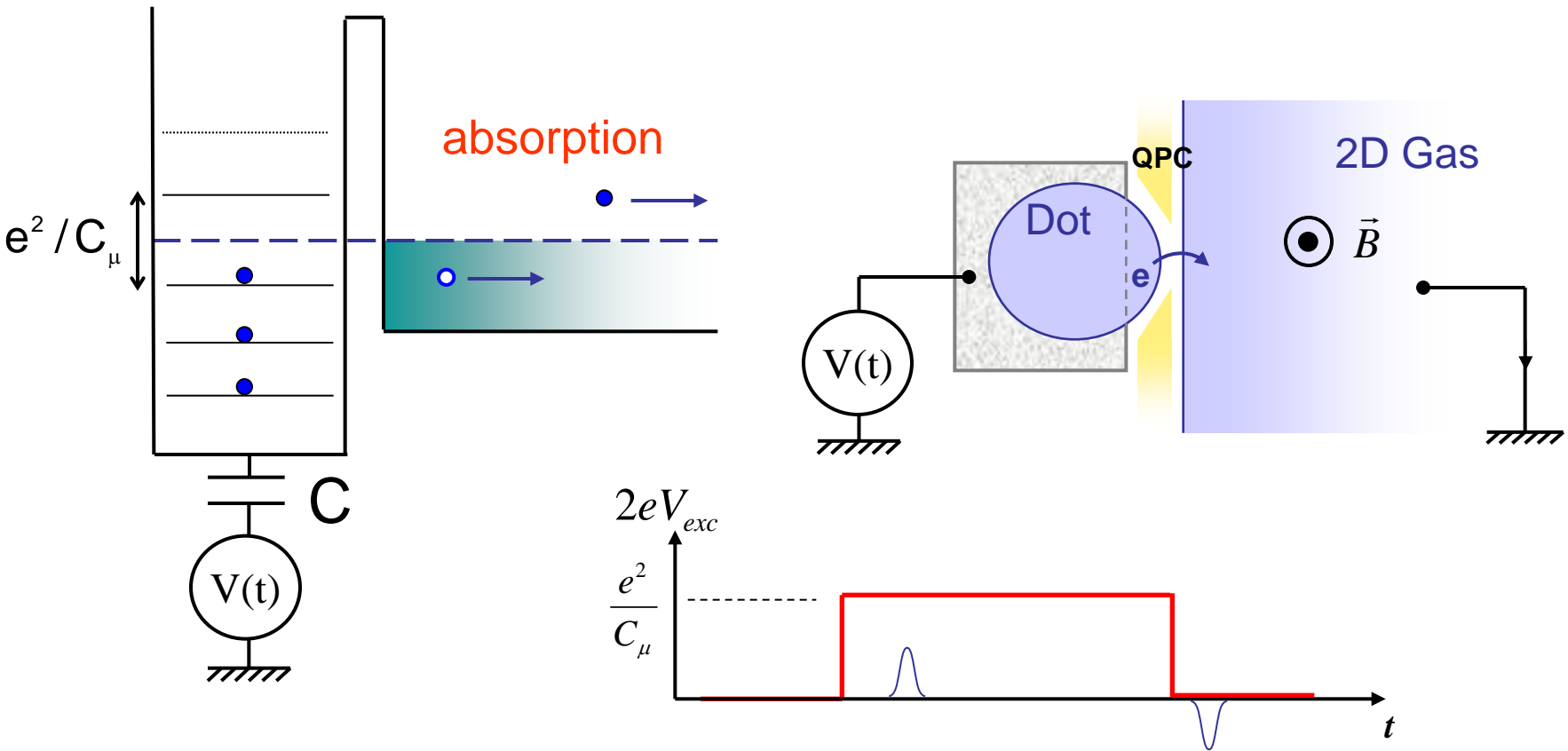

Principle of single electron injection

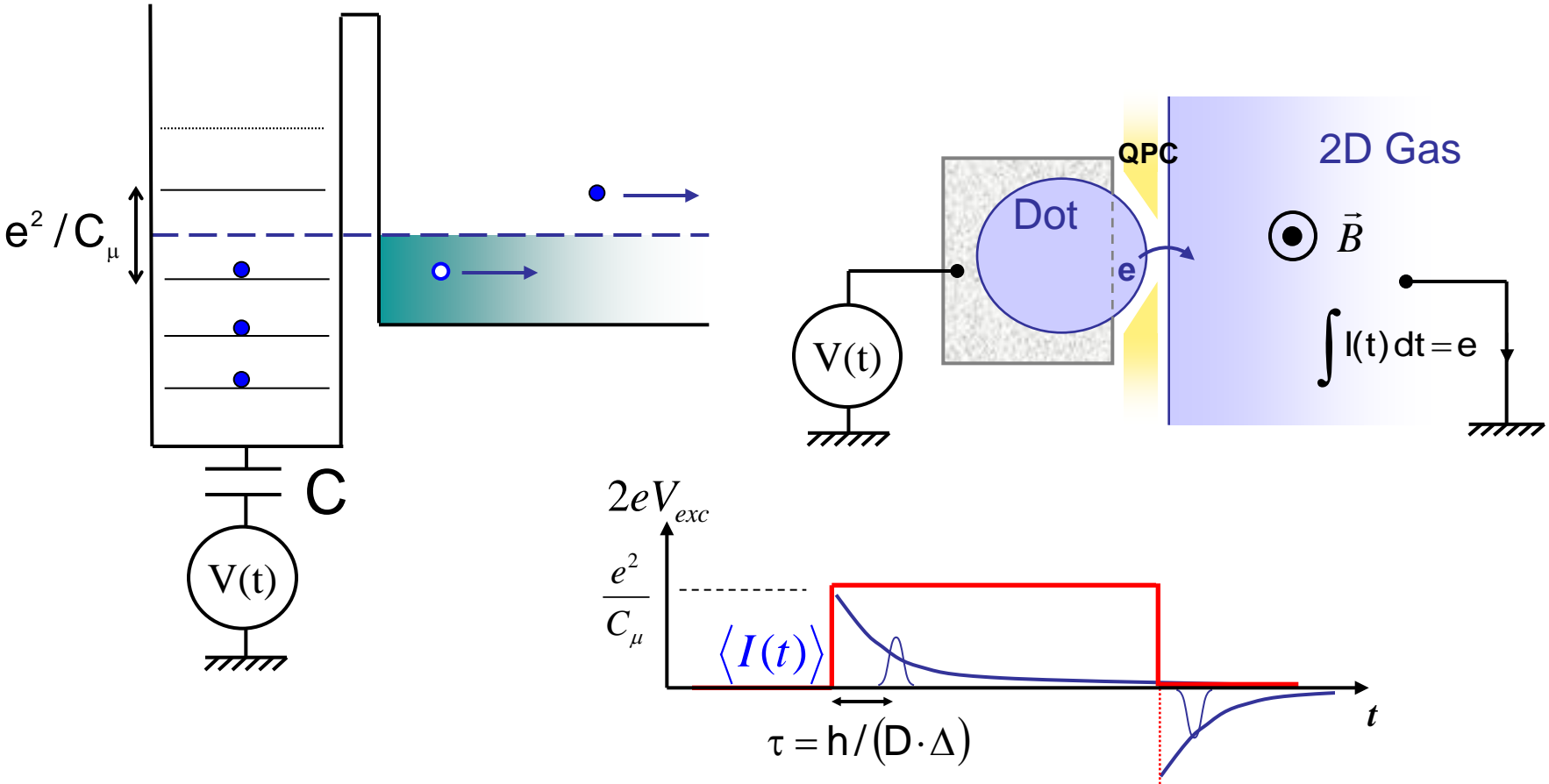

Experiment : time domain evolution of current

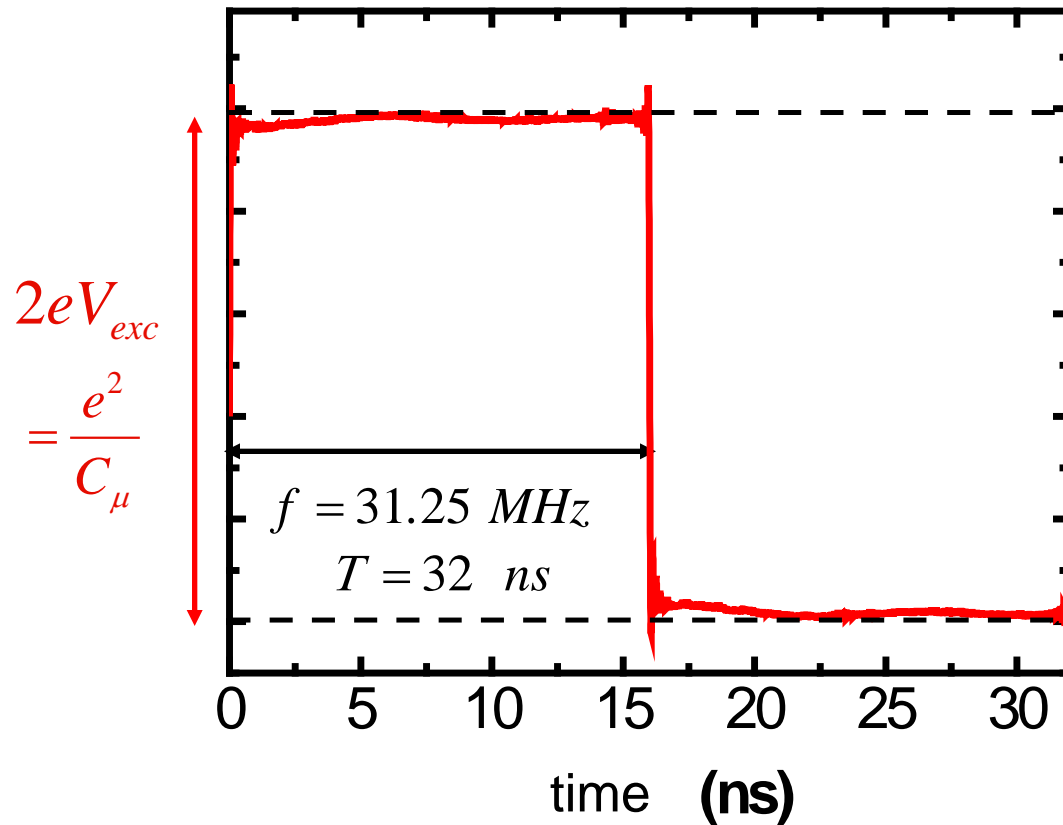

Bandwidth: 1GHz

Sampling time: 500 ps

→ $\tau \geq ns$

Acquisition time: ~ s

Experiment : time domain evolution of current

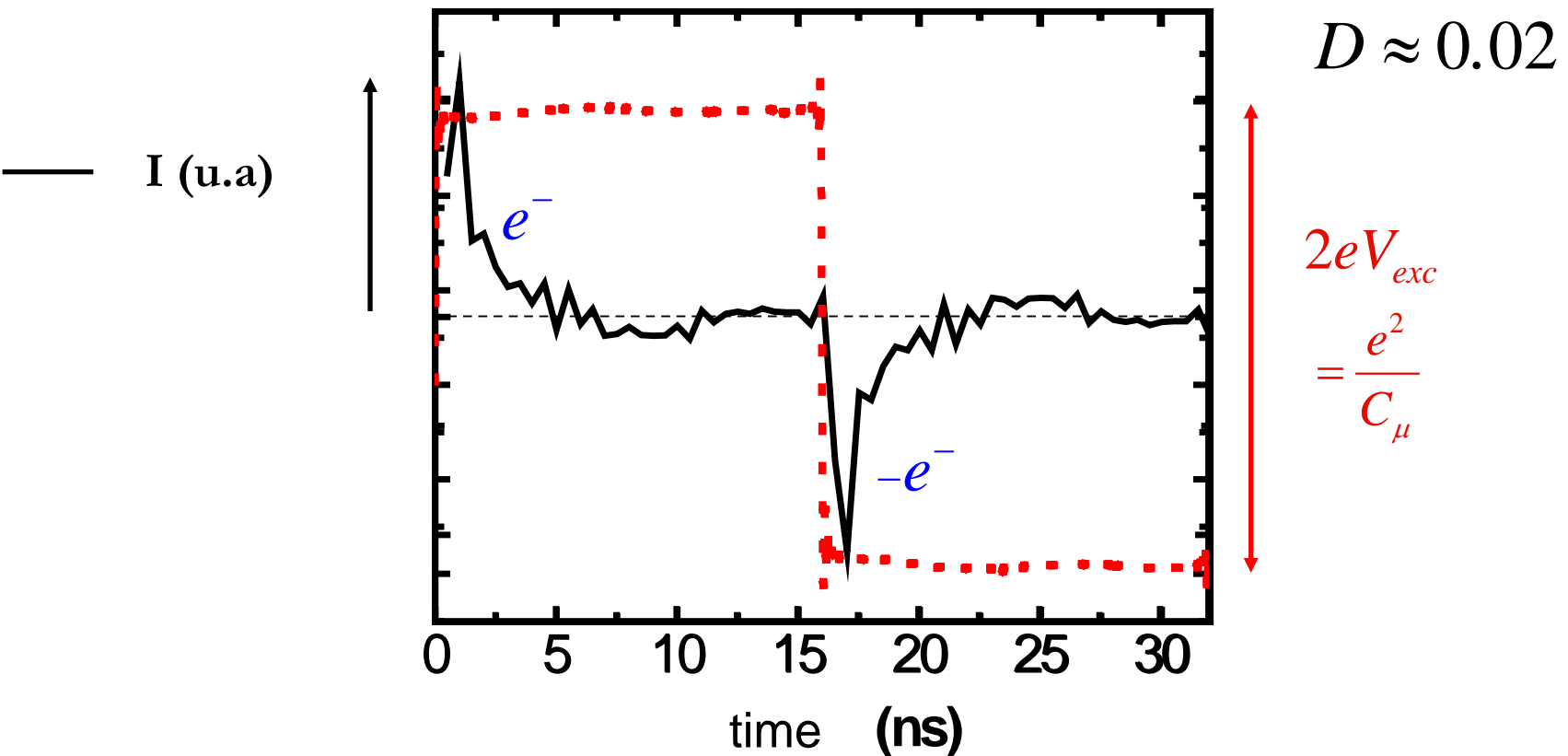

(G. Fève et al., *An On-Demand Coherent Single Electron Source*, *Science* **316** 1169 (2007))

(A. Mahé et al., *Subnanosecond single electron source in the time-domain*, submitted to *JLTP*, 2008)

Experiment : time domain evolution of current

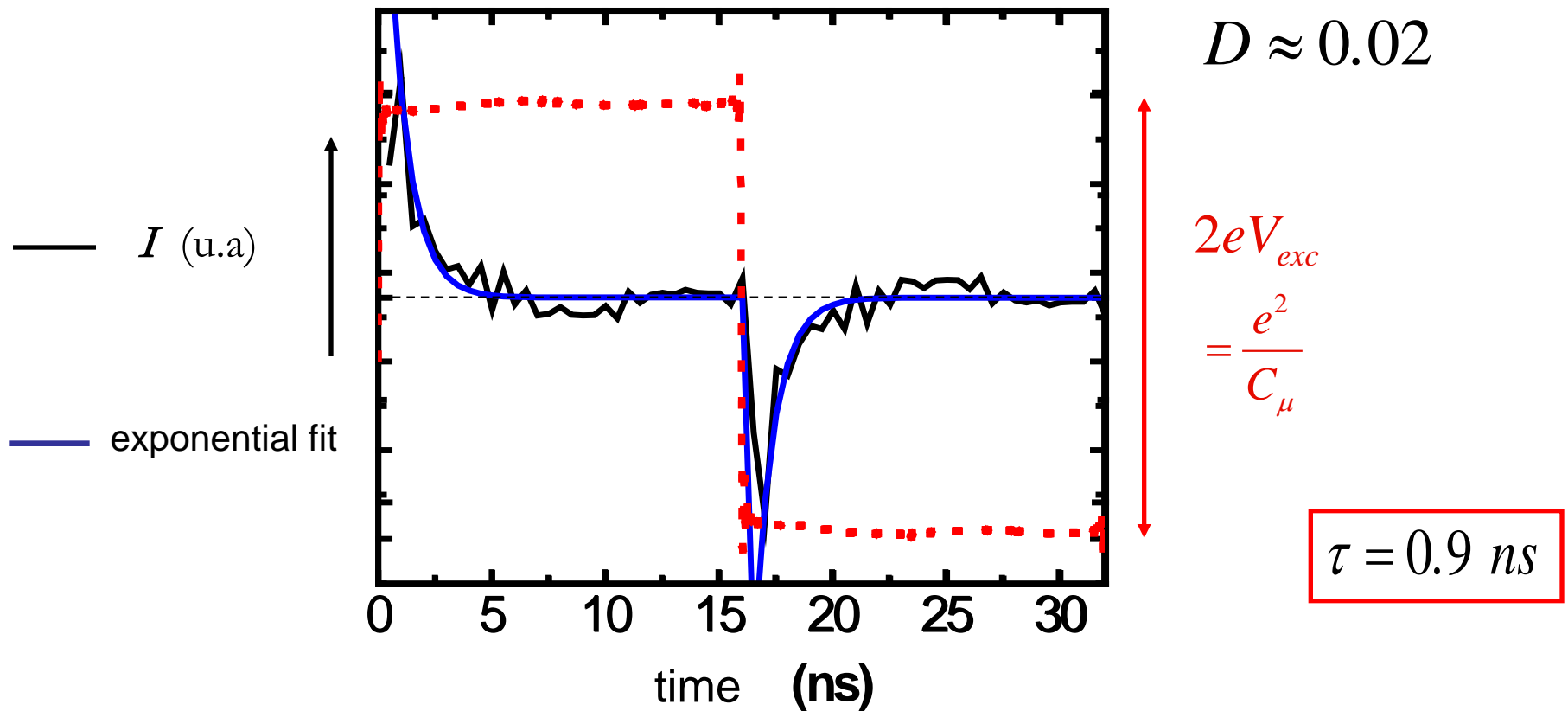

Experiment : time domain evolution of current

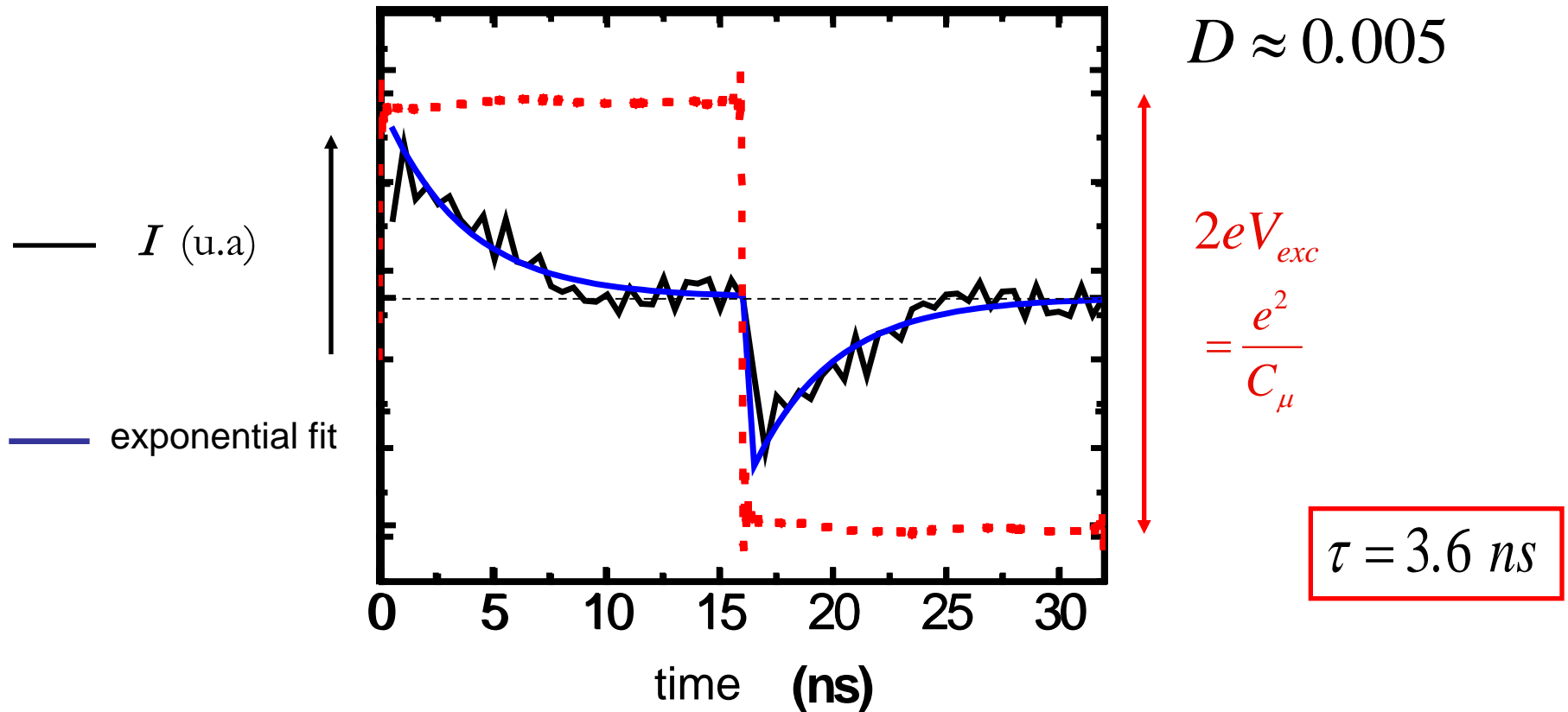

Time domain evolution of current

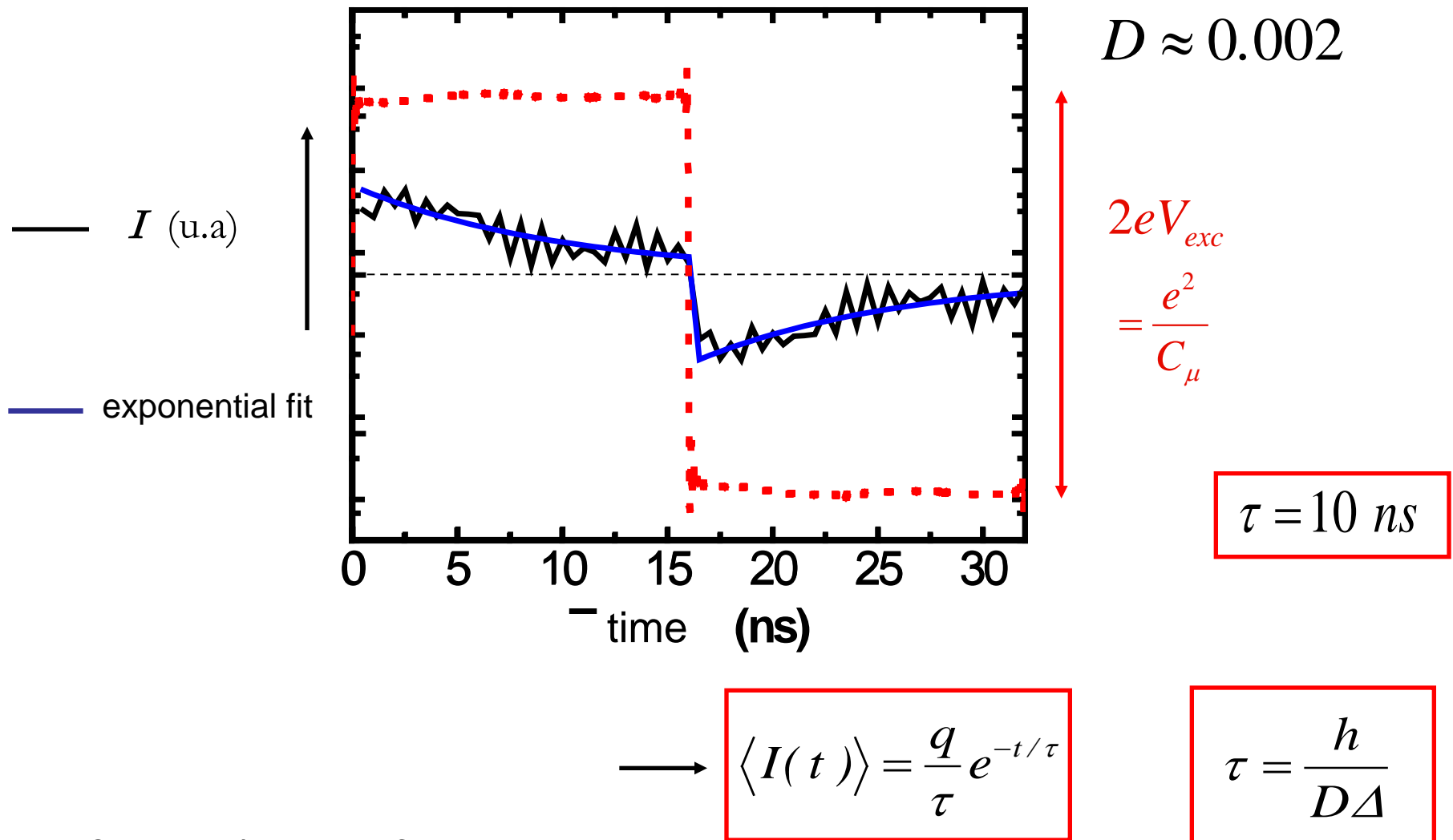

Experiment : time domain evolution of current

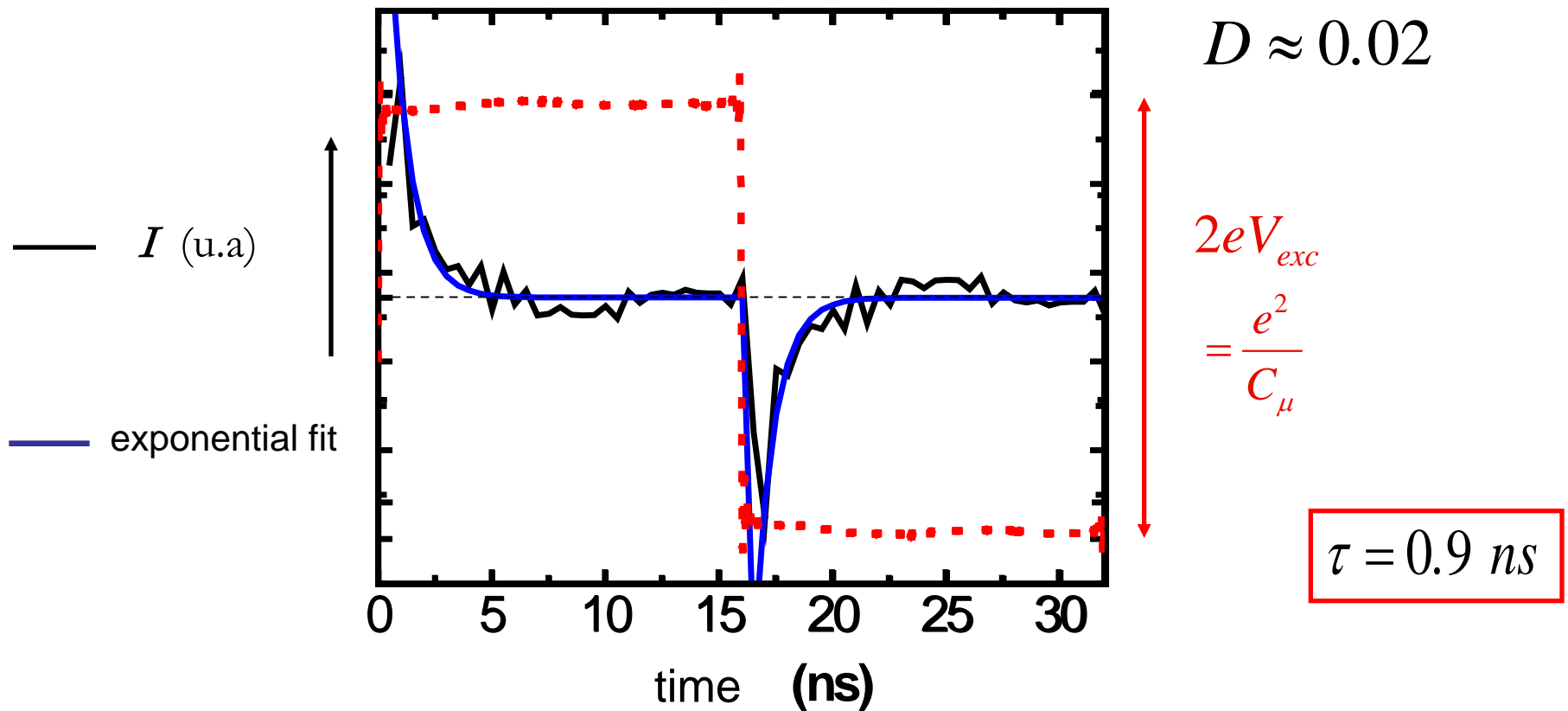

First harmonic of the current

$$\langle I_\omega \rangle = i \frac{2qf}{1 - i\omega\tau} \quad \omega\tau \ll 1 \rightarrow |I_\omega| = 2qf \quad , \quad \varphi \approx \tan\varphi = \omega\tau$$

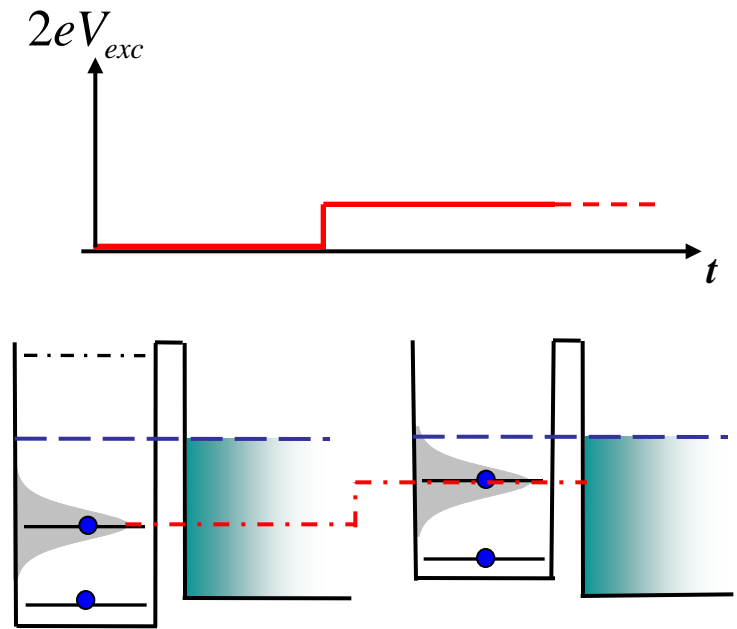
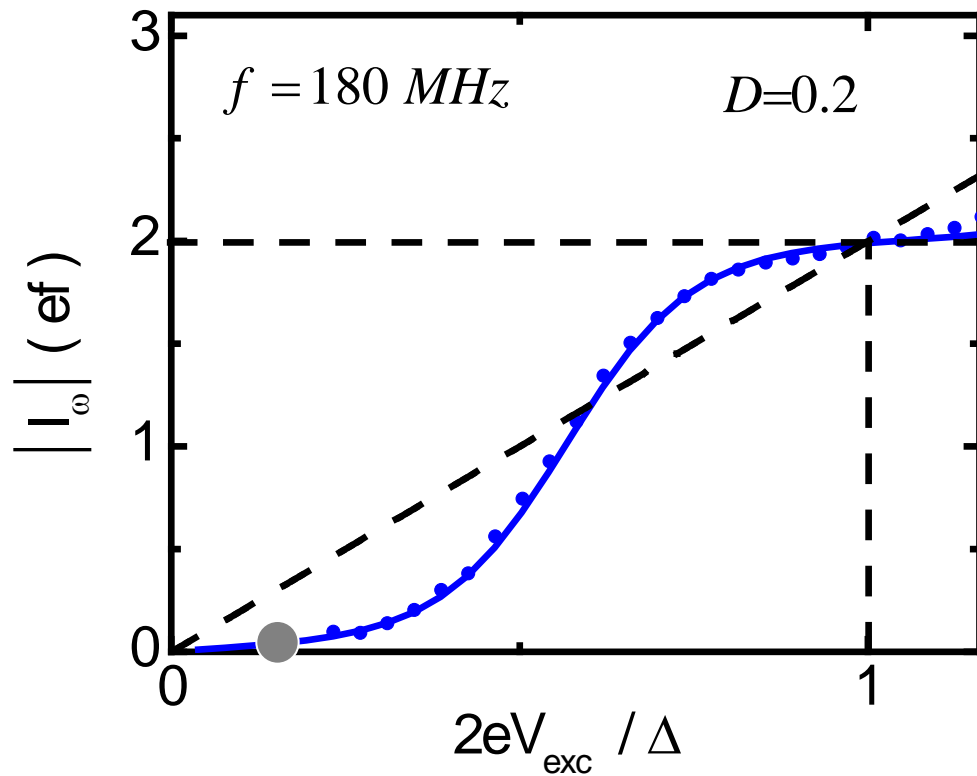

First harmonic of the current

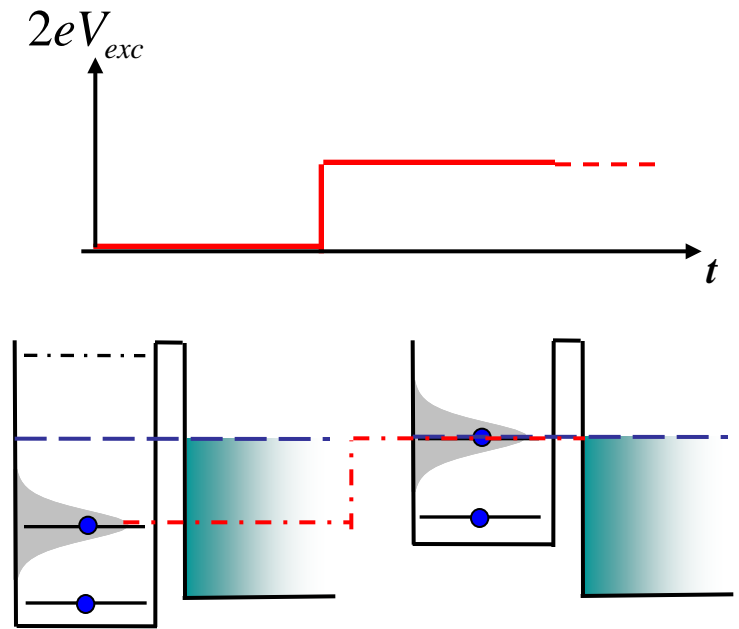
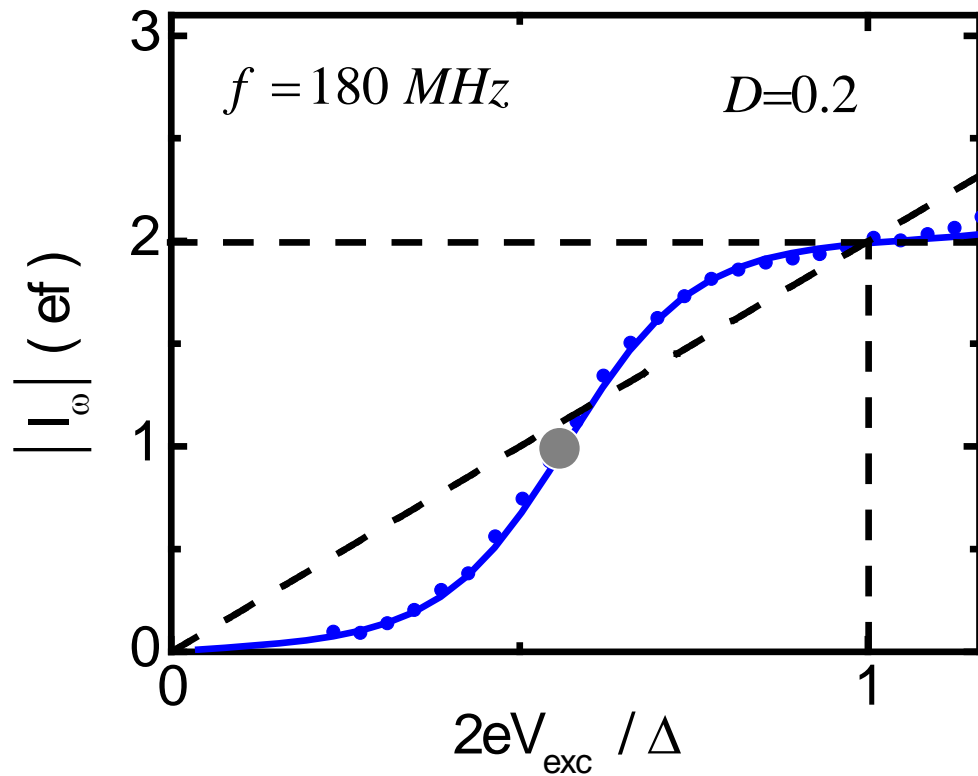

First harmonic of the current

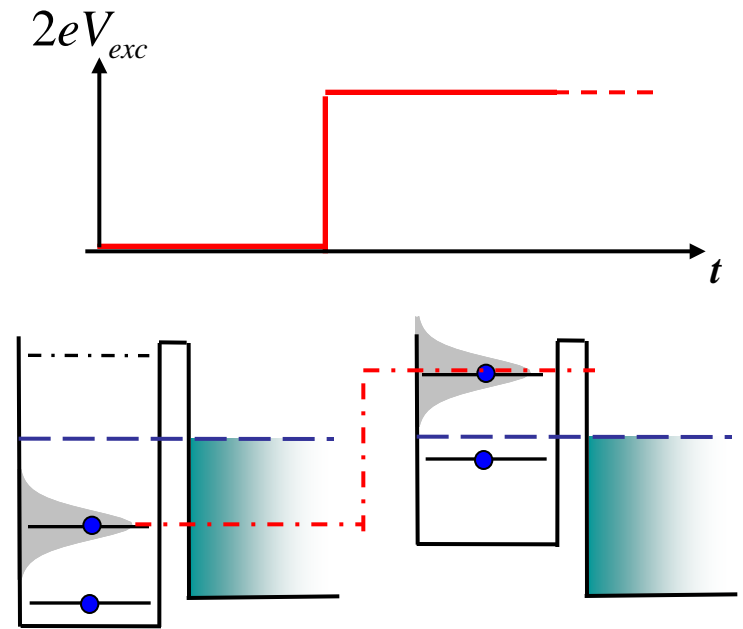
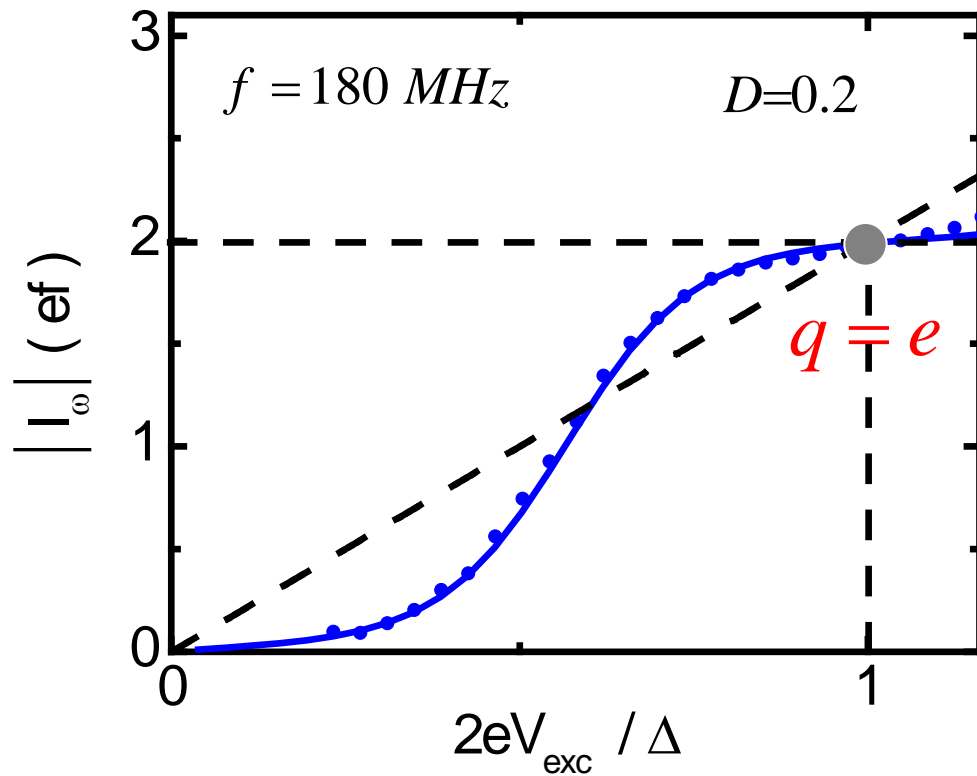

Dot-potential dependence

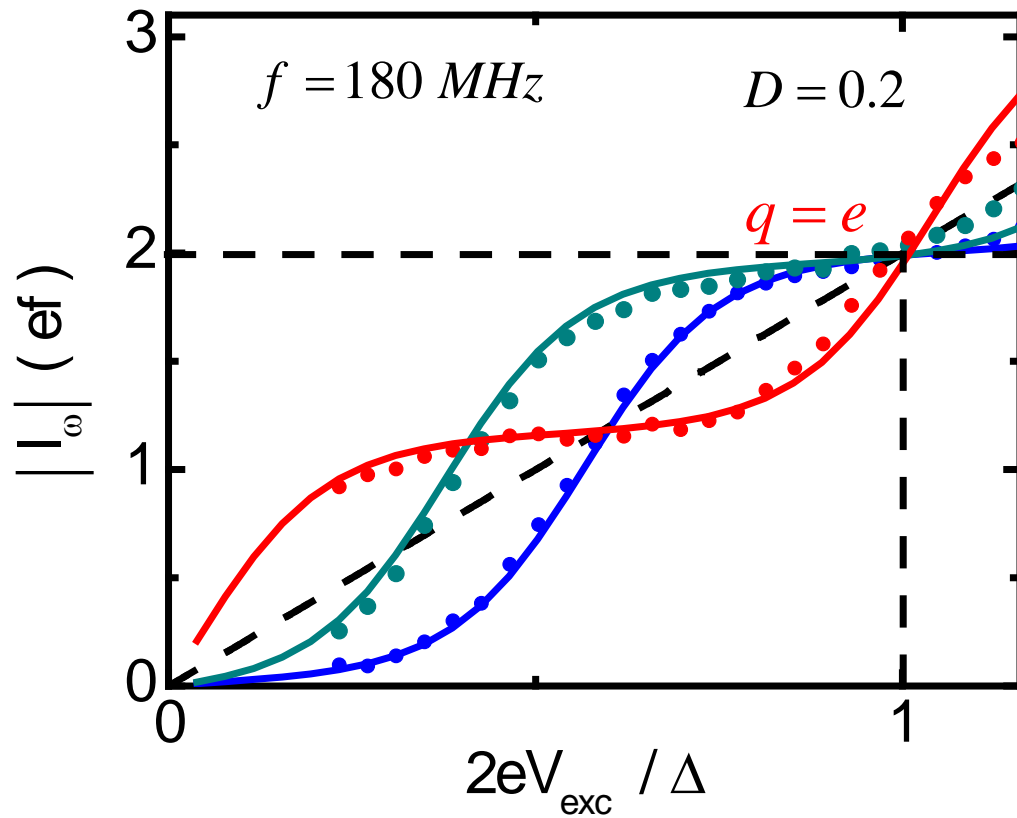

equilibrium potential :

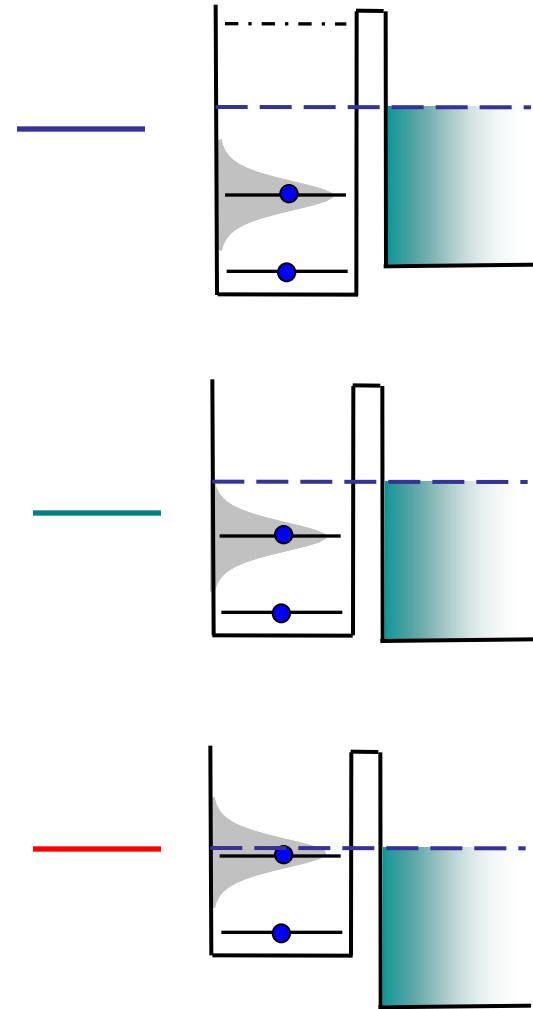

QPC transmission dependence

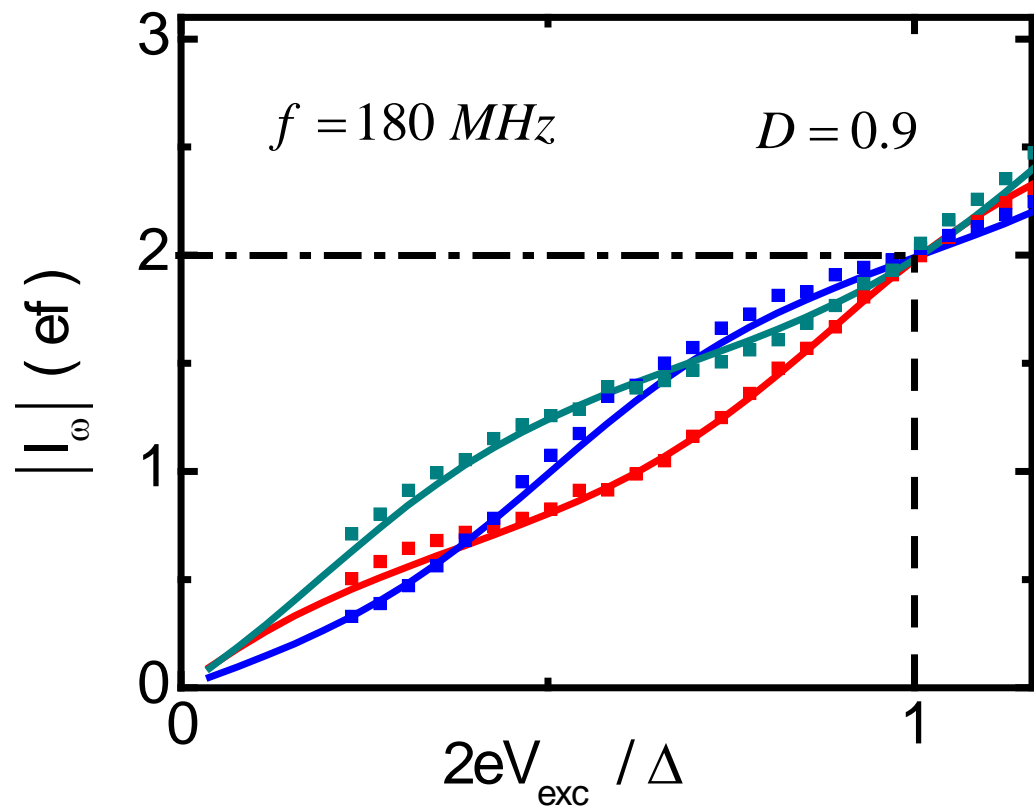

quantization lost by quantum fluctuations

equilibrium potential :

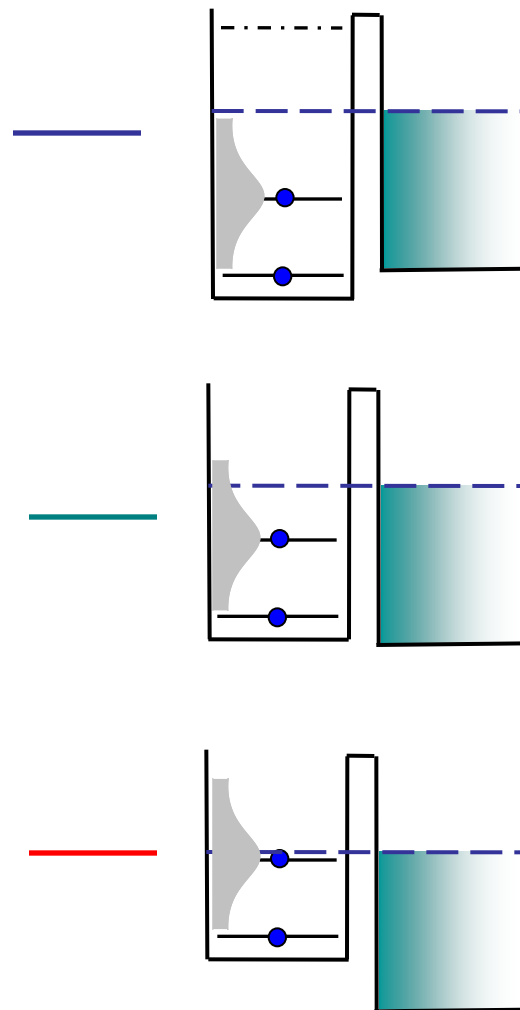

Comparison with 1D-model

Non linear scattering theory

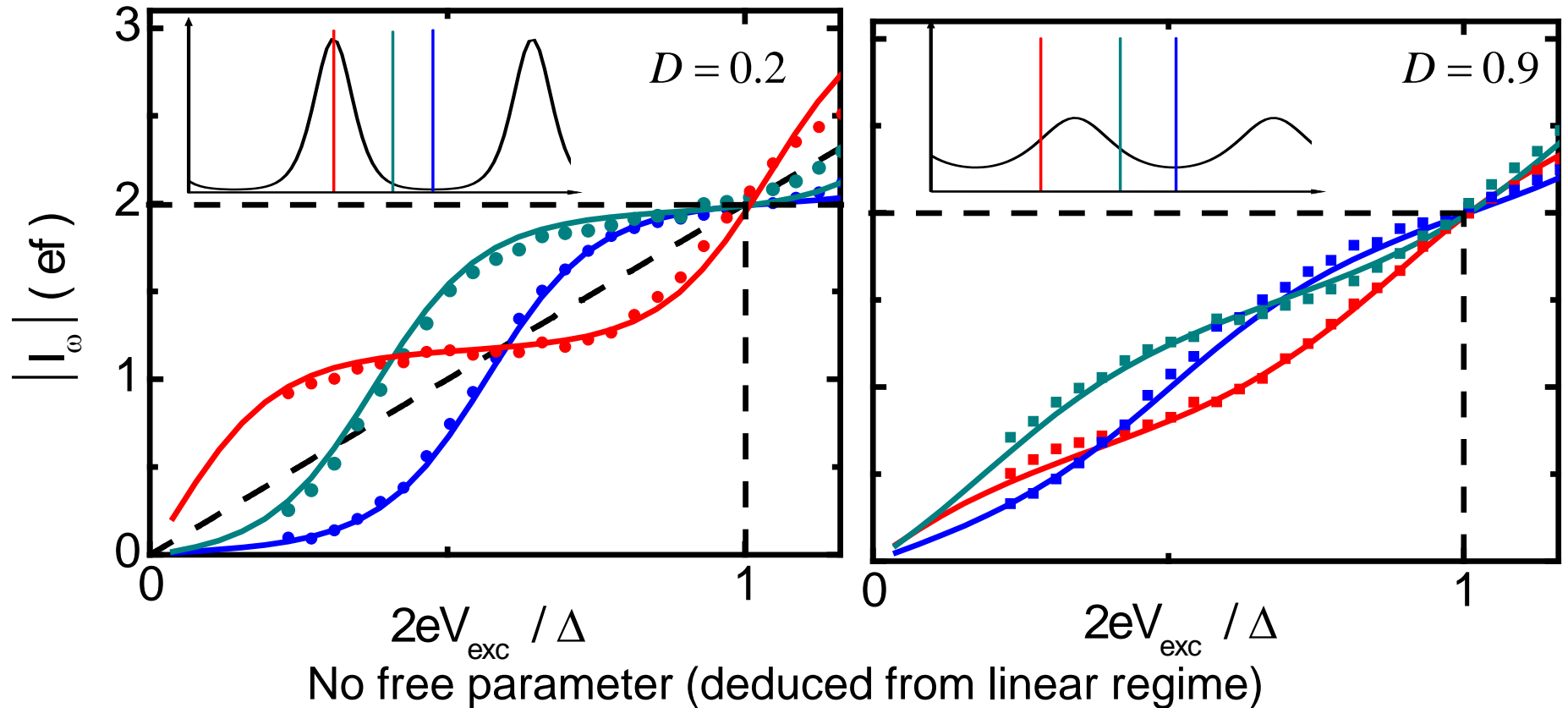

G.Fève et al Science 316 1169 (2007)

See also : *M. Moskalets et al. Phys. Rev. Lett. 100 086601 (2008)*

AC-current diamonds

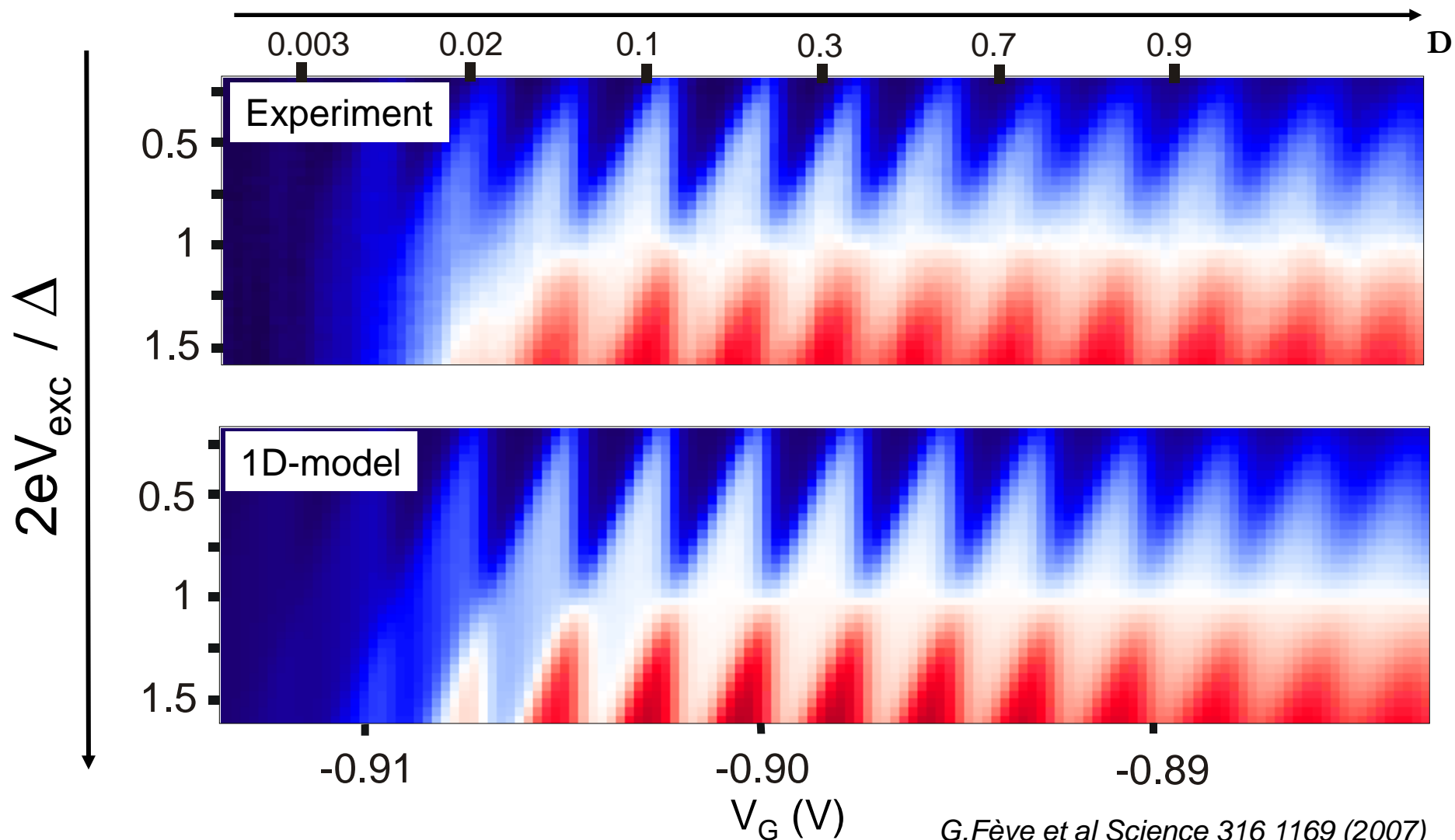
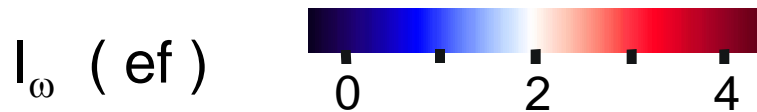

G.Fève et al Science 316 1169 (2007)

Single electron emission time

The phase is independent of dot potential and excitation amplitude

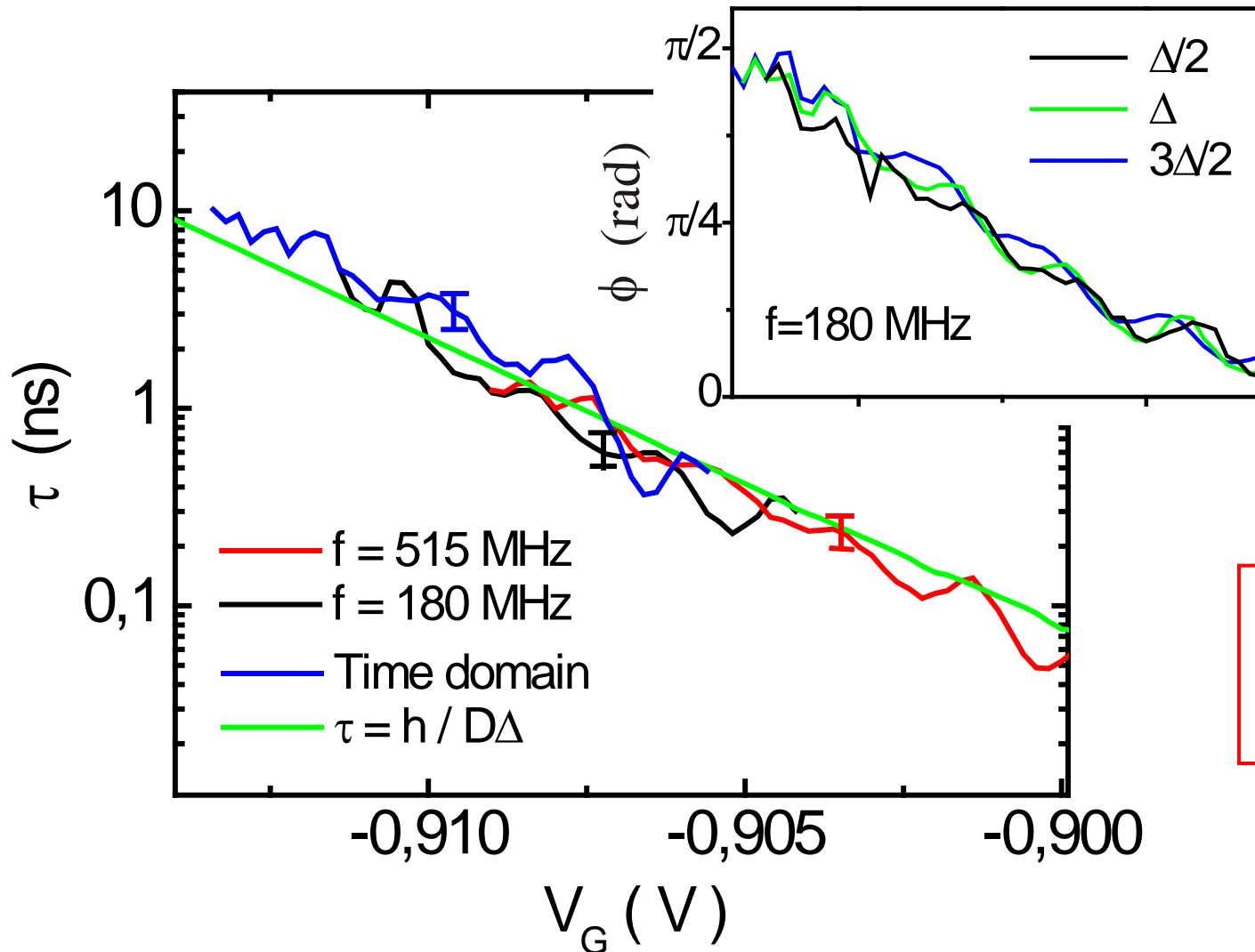

$$\tau = \frac{h}{D\Delta}$$

Vers la détection d'électrons volants

On the fly detection scheme ?

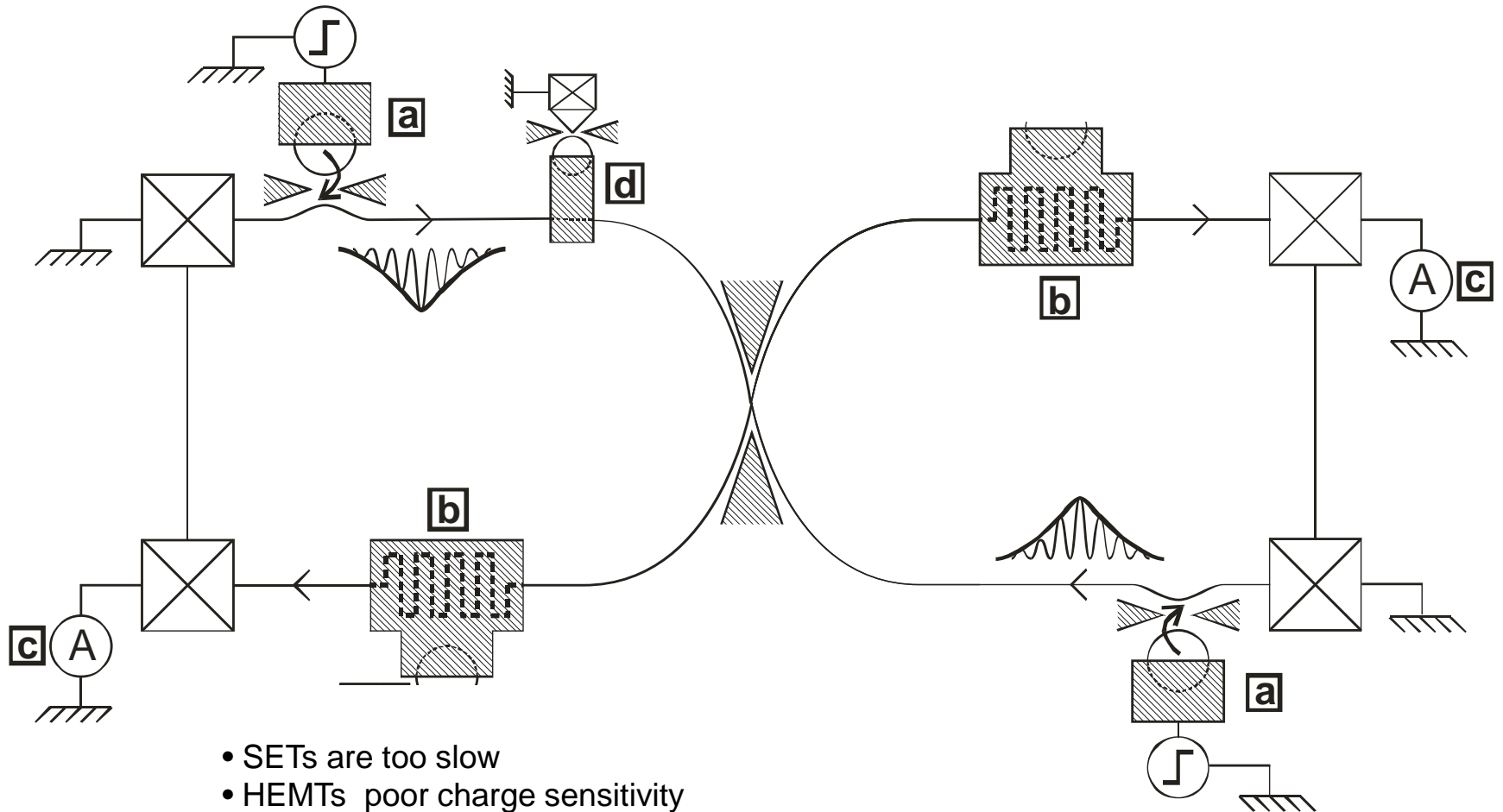

- SETs are too slow
- HEMTs poor charge sensitivity
- QPC-FETs more sensitive
- Nanotube-FETs even more sensitive

G.Fève, Quantum detection of electronic flying qubits, PRB77, 035308, (2008)

fin du cours !!

First harmonic measurement

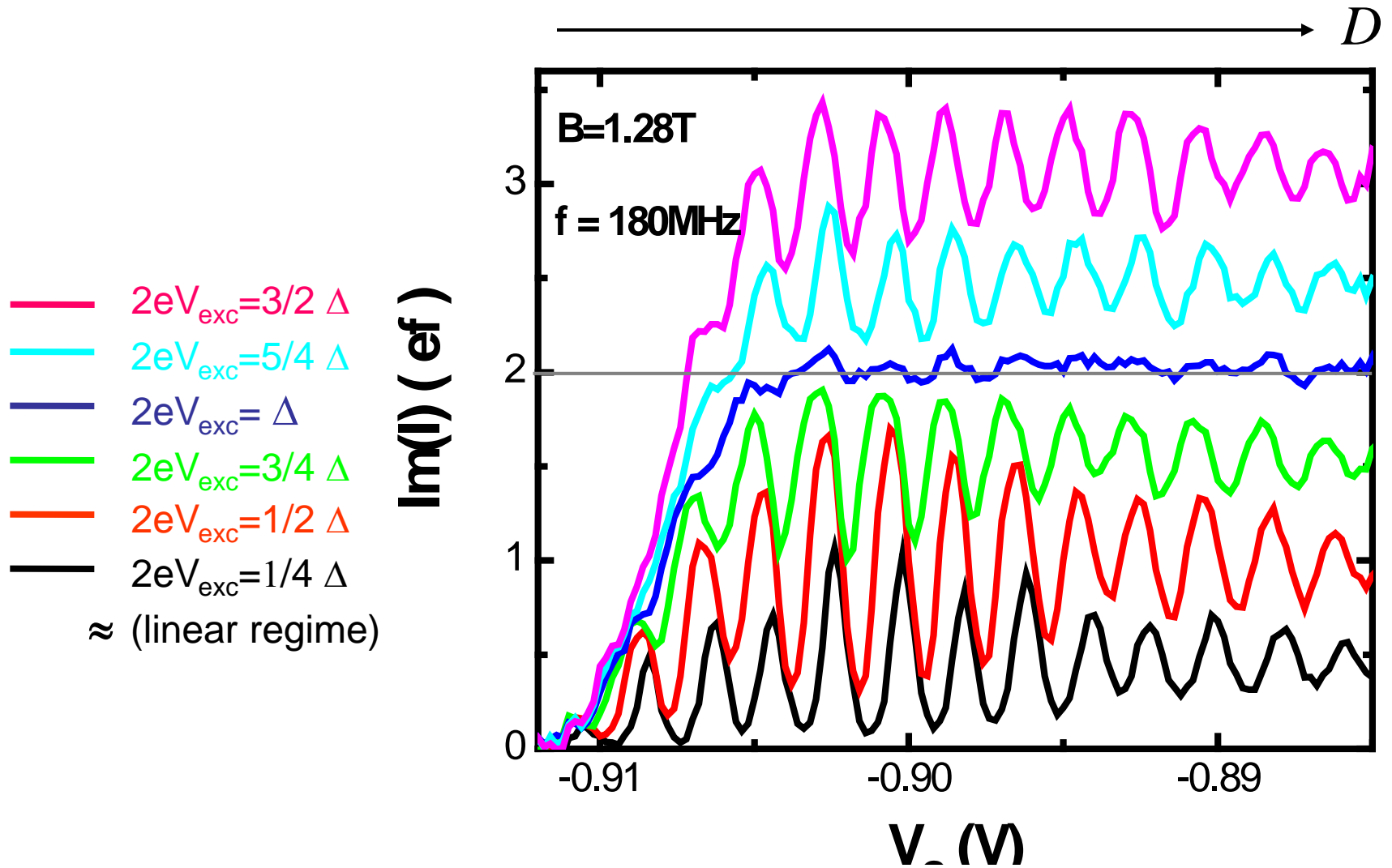

Corrélations de bruit : états de Bell à deux électrons

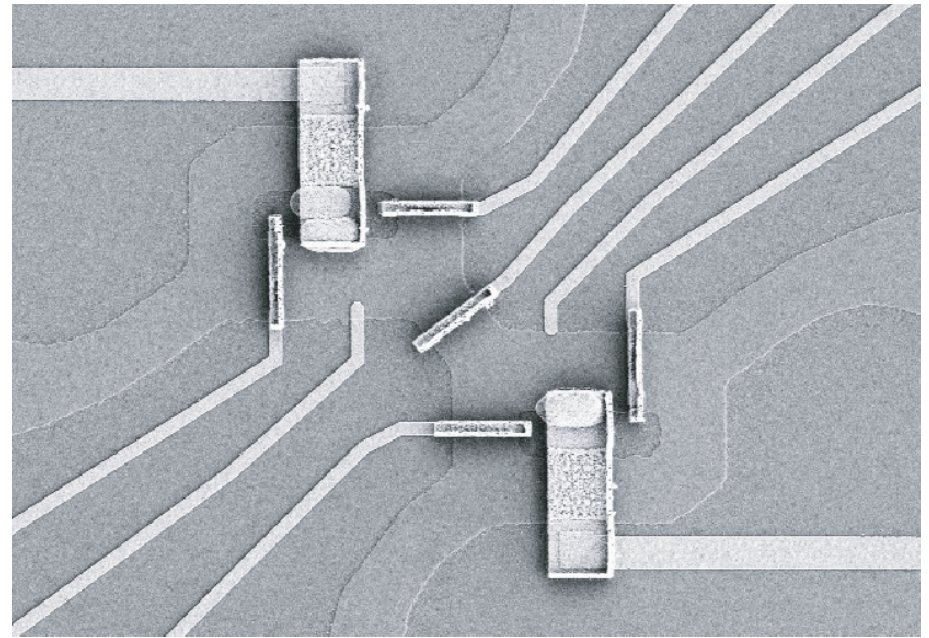
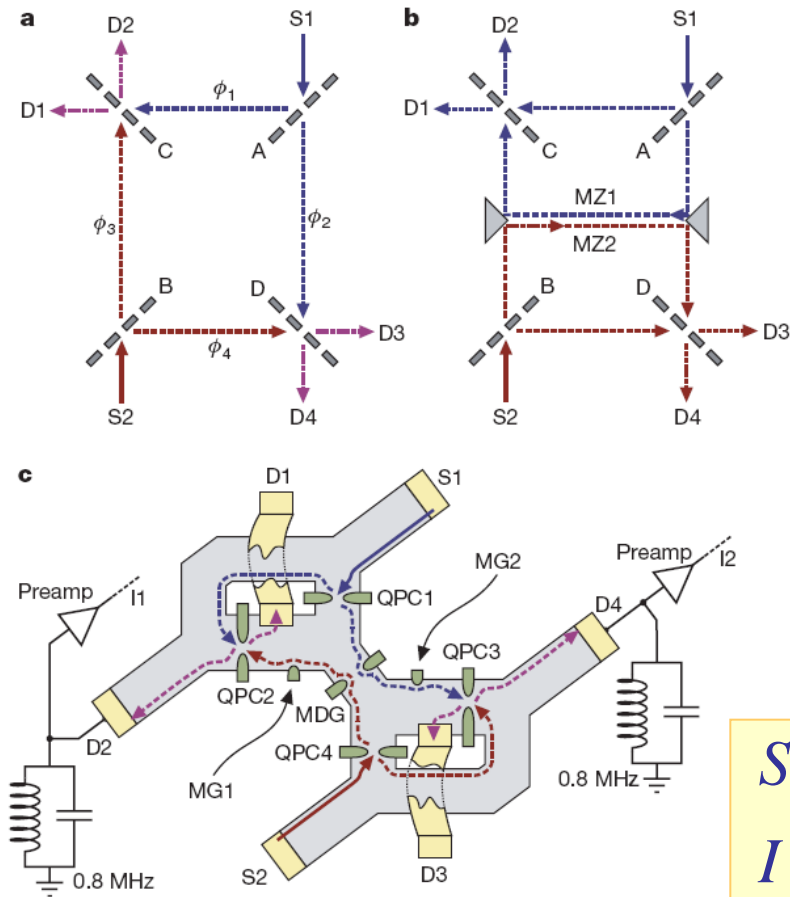

$$S_{D_2 D_4} = -0.25eI(1 - \sin \Phi_{tot} / \Phi_0)$$

$$I = I_{D_2} = I_{D_4} = 0.3 \text{ nA} \quad ; \quad V_{S_1} = V_{S_2} = 7 \mu\text{V}$$

Two-particle Aharonov-Bohm effect and entanglement in the electronic Hanbury Brown-Twiss setup.

Samuelsson, P., Sukhorukov, E. V. & Buttiker, M. *Phys. Rev. Lett.* 92, 026805 (2004).

Interference between two indistinguishable electrons from independent sources,

I. Neder, N. Ofek, Y. Chung, M. Heiblum, D. Mahalu and V. Umansky, *Nature* 448, 333 (2007).